



Introduction

Lipe have been noted for their range of hi torque, high performance CV clutches for over 50 years. Designed and built in the UK at our R & D and manufacturing centre in Haslingden, our ranges of pull and push type clutches suit virtually every heavy duty application on the roads today including a comprehensive range of spring diaphragm clutches suitable for vehicles from 7 tonne upwards.

This catalogue shows the Lipe Clutch Pack number in the highlighted column.

This pack includes cover and disc(s) and also a bearing in most cases.

The three following columns show the individual part numbers.

Our website www.setcoauto.com has all the latest models added to the site as soon as they are released.

Contents

	Page
The Lipe Clutch Range	2
Truck Application Catalogue	5
Bus Application Catalogue	58
Cross Reference Listing	60
Service Information Bulletins	64
Notes	77

Whilst every effort has been made to ensure the accuracy of information contained in this list, the company does not accept responsibility for errors.

The company reserves the right to alter part numbers and specifications without prior notification. Manufacturers' names and part numbers are used for reference purposes only.

PULL TYPE CLUTCHES



310 SINGLE
Cast Cover
Diaphragm Spring Pull Type
Single Plate



310 SINGLE
Pressed Steel Cover
Diaphragm Spring Pull Type
Single Plate



330 SINGLE
Pressed Steel Cover
Diaphragm Spring Pull Type
Single Plate



330 SINGLE
Cast Cover
Diaphragm Spring Pull Type
Single Plate Organic or Ceramic



14/352 SINGLE & TWIN
Pressed Steel Cover
Direct Pressure Coil Spring Pull Type
Single Plate
Twin Plate



14/352 SINGLE & TWIN
Cast Cover
Direct Pressure Coil Spring Pull Type
Single Plate
Twin Plate



14" SINGLE
Pressed Steel Cover
Diaphragm Spring Pull Type
Single Plate



15/380 SINGLE & TWIN
Cast Cover
Direct Pressure Coil Spring Pull Type
Single Plate
Twin Plate



395 SINGLE
Pressed Steel Cover
Diaphragm Spring Pull Type
Single Plate



400 TWIN
Pressed Steel Cover
Diaphragm Spring Pull Type
Twin Plate



430 SINGLE
Pressed Steel Cover
Diaphragm Spring Pull Type
Single Plate



430 SINGLE
Cast Cover
Diaphragm Spring
Single Plate Organic or Ceramic



OIL SPRAY DISC/ISOLATORS



TOOLS & COMPONENTS



PUSH TYPE CLUTCHES



330 SINGLE & TWIN
Direct Pressure Coil Spring Push Type
Single Plate
Twin Plate



330 SINGLE
Pressed Steel Cover
Diaphragm Spring Push Type

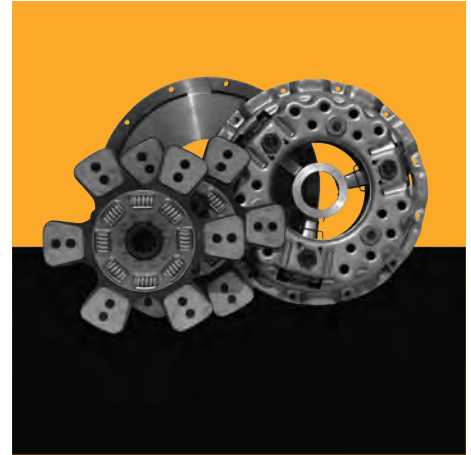

14 SINGLE & TWIN
Direct Pressure Coil Spring Push Type
Single Plate
Twin Plate



362 SINGLE
Pressed Steel Cover
Diaphragm Spring Push Type
Single Plate



15/380 SINGLE & TWIN
Direct Pressure Coil Spring Push Type
Single Plate
Twin Plate



395 SINGLE
Pressed Steel Cover
Diaphragm Spring Push Type
Single Plate



16.5/420 SINGLE
Cast Cover
Direct Pressure Coil Spring Push Type
Single Plate



Vehicle

Year



Engine



Gearbox



LIPE Kit No.



LIPE cover



LIPE Disc

LIPE
Bearing

Notes

ASHOK-LEYLAND

Vehicle	Year	Engine	Gearbox	LIPE Kit No.	LIPE cover	LIPE Disc	LIPE Bearing	Notes
2516Tipper		Ashok				380-009-L2328 1 1/2" x 10		
3516Truck		Ashok Hino				380-009-L2328 1 1/2" x 10		
2516H Haulage		Ashok				140-009-L2327 1 1/2" x 10		
4018Tractor		Hino				380-009-L2328 1 1/2" x 10		

ASIA MOTOR WORKS

2214						140-009L2327		
1616H					380-019-L4208	140-009-L2328		
2516						140-009-L2328		
2518TP					380-061-L4188	380-009-L4187		
2518 HL					380-061-L4188	380-009-L4187		
2518TM					380-061-L4188	380-009-L4187		
4018TR						380-009-L2558		
4921						380-009-L2558		

AVIA/DAEWOO**Truck**

D75	00-Ch	Cummins ISB150/170	ZF S5-42	AKB-L3155	362-071-L3145	362-019-L3147 1 1/2" x 10	CB-L3142	
D75	Ch-	Cummins ISB150/170	ZF S5-42	AKB-L3157	362-071-L3146	362-019-L3148 1 1/2" x 10	CB-L3142	
D75/62	00-Ch	Cummins ISB150	ZF S5-42	AKB-L3155	362-071-L3147	362-019-L3147 1 1/2" x 10	CB-L3142	
D75/62	Ch-	Cummins ISB150	ZF S5-42	AKB-L3157	362-071-L3148	362-019-L3148 1 1/2" x 10	CB-L3142	
D75T	00-Ch	Cummins ISB150/170	ZF S5-42	AKB-L3155	362-071-L3149	362-019-L3147 1 1/2" x 10	CB-L3142	
D75T	Ch-	Cummins ISB150/170	ZF S5-42	AKB-L3157	362-071-L3150	362-019-L3148 1 1/2" x 10	CB-L3142	
D90	00-Ch	Cummins ISB150/170	ZF S6-850	AKB-L3156	362-071-L3151	362-019-L3147 1 1/2" x 10		
D90	Ch-	Cummins ISB150/170	ZF S6-850	AKB-L3158	362-071-L3152	362-019-L3148 1 1/2" x 10		

AWD UK

TL7-14		Phaser 145		AKL0902 AKL0908				
TL8-14		Phaser 145		AKL0902 AKL0908				
TL9-14		Phaser 145		AKL0902 AKL0908				
TL10-14		Phaser 145		AKL0902 AKL0908				
TL12-16		Phaser 160T	Eaton	AKL0903				
TL13-16		Phaser 160T	Spicer	AKL0903				
TL18-16		Phaser 160T	Eaton	AKL0903				
TL20-16		Phaser 160T	Spicer	AKL0983				
TL17-18		Phaser 180TI	Eaton	AKL0903				
TL18-18		Phaser 180TI	Eaton	AKL0903				
TL20-18		Phaser 180TI	Eaton	AKL0903				
TL21-18		Phaser 180TI	Eaton	AKL0903				
ZRT		Phaser 180TI		LP-L0759-656				
TL17-27		6CTAA 8-3		LP-L0692-608				
TL24-27				LP-L0692-608				
MTL				LP-L0692-608				



Vehicle

Year



Engine



Gearbox



LIPE Kit No.



LIPE cover



LIPE Disc

LIPE
Bearing

Notes

BEDFORD**TM**

80-85 500 Turbo Diesel AKB-L2273

DAF (INC. LEYLAND)**Blueline**

Bear	88-	302		AKB-L1817	330-301-L1830	130-019-L1842 1 1/2" x 10
Comet	88-	302		AKB-L1817	330-301-L1830	130-019-L1842 1 1/2" x 10
Super Comet	88-	302		AKB-L1817	330-301-L1830	130-019-L1842 1 1/2" x 10

Freighter

13.13	86-90	302	Turner T5-300	AKB-L1817	330-301-L1830	130-019-L1842 1 1/2" x 10
14.13	86-90	302	Turner T5-300	AKB-L1817	330-301-L1830	130-019-L1842 1 1/2" x 10

Roadrunner

6.15	87-90	310 Turbo	Turner T5-300	AKB-L1817	330-301-L1830	130-019-L1842 1 1/2" x 10
8.15	87-91	310 Turbo	Turner T5-300	AKB-L1817	330-301-L1830	130-019-L1842 1 1/2" x 10
10.15	87-91	310 Turbo	Turner T5-300	AKB-L1817	330-301-L1830	130-019-L1842 1 1/2" x 10

45 Series

45.150 Rigid	91-01	CB108 CT108L	ZF S5-42	AKB-L1817	330-301-L1830	130-019-L1842 1 1/2" x 10
45.160 Rigid	91-01	CS119L CT119	ZF S5-42	AKB-L1817	330-301-L1830	130-019-L1842 1 1/2" x 10

LF45 SERIES

LF45.130	01-	BE99	ZF 5S-42	AKB-L2505	362-071-L3139	362-019-L3133 1 1/2" x 10	CB-L3141
LF45.140	05/06-	FR103		AKB-L2505	362-071-L3139	362-019-L3133 1 1/2" x 10	CB-L3141
LF45.150	01-	BE110	ZF 5S-42	AKB-L2505	362-071-L3139	362-019-L3133 1 1/2" x 10	CB-L3141
LF45.150	01-	BE110	ZF 6S 850	AKB-L2506	395-071-L3098	395-019-L3101 1 1/2" x 10	CB-L1847
LF45.160	05/06-	FR118		AKB-L3599	362-071-L3139	362-019-L3600 1 3/4" x 10	CB-L3598
LF45.170	01-	BE123	ZF 5S-42	AKB-L2505	362-071-L3139	362-019-L3133 1 1/2" x 10	CB-L3141
LF45.170 Bin Wagon	01-	BE123	ZF 5S-42	AKB-L3601	362-071-L3139	362-019-L3133 1 1/2" x 10	CB-L1847
LF45.170	01-	BE123	ZF 6S-850	AKB-L2506	395-071-L3098	395-019-L3101 1 1/2" x 10	CB-L1847
LF45.180	01-	CE136	ZF 5S-42	AKB-L2505	362-071-L3139	362-019-L3133 1 1/2" x 10	CB-L3141
LF45.180	01-	CE136	ZF 6S-850	AKB-L2506	395-071-L3098	395-019-L3101 1 1/2" x 10	CB-L1847
LF45.180	05/06	FR136		AKB-L3599	362-071-L3139	362-019-L3600 1 3/4" x 10	CB-L3598
LF45.220	01-	CE162	ZF 5S-42	AKB-L2505	362-071-L3139	362-019-L3133 1 1/2" x 10	CB-L3141
LF45.220	01-	CE162	ZF 6S-850	AKB-L2506	395-071-L3098	395-019-L3101 1 1/2" x 10	CB-L1847

50 SERIES

50.150	90-96	310 CT108	ZF S6-36	AKB-L1817	330-301-L1830	130-019-L1842 1 1/2" x 10
--------	-------	-----------	----------	-----------	---------------	------------------------------



Vehicle

Year



Engine



Gearbox



LIPE Kit No.



LIPE cover



LIPE Disc

LIPE
Bearing

Notes

DAF (INC. LEYLAND) Cont'd**55 Series**

55.130	95-01	CT96	ZF S6-36	AKB-L1817	330-301-L1830	130-019-L1842 1 1/2" x 10	
55.150	96-99	CS107	ZF S6-36	AKB-L1817	330-301-L1830	130-019-L1842 1 1/2" x 10	

LF55 Series

LF55.170	01-	BE123	Eaton 6309	AKB-L2915	395-071-L3098	395-019-L3102 1 3/4" x 10	CB-L1847
LF55.170	01-	BE123	ZF 6S-850	AKB-L2506	395-071-L3098	395-019-L3101 1 1/2" x 10	CB-L1847
LF55.170 Roadsweeper	01-	BE123	ZF 6S-850	AKB-L3601	362-071-L3139	362-019-L3133 1 1/2" x 10	CB-L1847
LF55.180	01-	CE136	Eaton 6309	AKB-L2915	395-071-L3098	395-019-L3102 1 3/4" x 10	CB-L1847
LF55.180	01-	CE136	ZF 6S-850	AKB-L2506	395-071-L3098	395-019-L3101 1 1/2" x 10	CB-L1847
LF55.180	05/06	FR136		AKB-L3599	362-071-L3139	362-019-L3600 1 3/4" x 10	CB-L3598
LF55.220	01-	CE162	Eaton 6309	AKB-L2915	395-071-L3098	395-019-L3102 1 3/4" x 10	CB-L1847
LF55.220	01-	CE162	ZF 6S-850	AKB-L2506	395-071-L3098	395-019-L3101 1 1/2" x 10	CB-L1847
LF55.220	05/06	GR165					CB-L3598
LF55.250	01-	CE184	Eaton 6309	AKB-L2915	395-071-L3098	395-019-L3102 1 3/4" x 10	CB-L1847
LF55.250	01-	CE184	ZF 6S-850	AKB-L2506	395-071-L3098	395-019-L3101 1 1/2" x 10	CB-L1847
LF55.250	05/06	GR184					CB-L3598
LF55.290	05/06	GR210					CB-L3598

65 Series

65.210	93-98	NS156	ZF 6S-36	AKB-L2279	362-071-L3139	362-019-L3131 1 1/2" x 10	CB-L3142
65.210	93-98	NS156	ZF 9S-75	AKB-L2917	362-071-L3139	362-019-L3132 1 3/4 x 10	CB-L1847
65.240	96-98	NS177	ZF 9S-75	AKB-L2917	362-071-L3139	362-019-L3132 1 3/4 x 10	CB-L1847

65CF Series

65CF210	98-01	NS156	ZF 6S-36	AKB-L2279	362-071-L3139	362-019-L3131 1 1/2" x 10	CB-L3142
65CF210	98-01	NS156	ZF 9S-75	AKB-L2917	362-071-L3139	362-019-L3132 1 3/4 x 10	CB-L1847
65CF240	98-01	NS177	ZF 6S-36	AKB-L2279	362-071-L3139	362-019-L3131 1 1/2" x 10	CB-L3142
65CF240	98-01	NS177	ZF 9S-75	AKB-L2917	362-071-L3139	362-019-L3132 1 3/4 x 10	CB-L1847

CF65 SERIES









CF65.180	01-	CE136	ZF 6S-850	AKB-L2506	395-071-L3098	395-019-L3101 1 1/2" x 10	CB-L1847
CF65.220	01-	CE162	ZF 6S-850	AKB-L2506	395-071-L3098	395-019-L3101 1 1/2" x 10	CB-L1847
CF65.250	01-	CE184	ZF 6S-850	AKB-L2506	395-071-L3098	395-019-L3101 1 1/2" x 10	CB-L1847







75CF Series

75CF.320	98-01	PF235	ZF 8S-151	AKB-L2008	430-701-L2320	430-019-L3040 2" x 10	CB-L1961
----------	-------	-------	-----------	-----------	---------------	--------------------------	----------







CF75 SERIES

CF75.250	01-	PE183	ZF 8S-151 ZF 16S-151	AKB-L2008	430-701-L2320	430-019-L3040 2" x 10	CB-L1961
CF75.310	01-	PE228	ZF 8S-151 ZF 16S-151	AKB-L2008	430-701-L2320	430-019-L3040 2" x 10	CB-L1961
CF75.360	01-	PE 265	ZF 8S-151 ZF 16S-151	AKB-L2008	430-701-L2320	430-019-L3040 2" x 10	CB-L1961

 Vehicle	 Year	 Engine	 Gearbox	 LIPE Kit No.	 LIPE cover	 LIPE Disc	 LIPE Bearing	Notes
DAF (INC. LEYLAND) Cont'd								
85CF Series								
85CF340	98-01	XF250	ZF 16S-151	AKB-L2008	430-701-L2320	430-019-L3040 2" x 10	CB-L1961	
85CF380	98-01	XF280	ZF 16S-181	AKB-L2008	430-701-L2320	430-019-L3040 2" x 10	CB-L1961	
85CF430	98-01	XF315	ZF 16S-181	AKB-L2008	430-701-L2320	430-019-L3040 2" x 10	CB-L1961	
CF85 Series								
CF85.340	01-	XE250	ZF 16S-151 ZF 16S-181 ZF 16S-221	AKB-L2008	430-701-L2320	430-019-L3040 2" x 10	CB-L1961	
CF85.360	10/06 -	MX275	Ecosplit	AKB-L3620	430-701-L2320	430-019-L2321 2" x 10	CB-L1961	
CF85.360	10/06 -	MX275	ASTronic	AKB-L3602	430-701-L2320	430-019-L3040 2" x 10	CB-L3490	
CF85.380	01-	XE280	ZF 16S-151 ZF 16S-181 ZF 16S-221	AKB-L2008	430-701-L2320	430-019-L3040 2" x 10	CB-L1961	
CF85.410	10/06 -	MX300	Ecosplit	AKB-L3620	430-701-L2320	430-019-L2321 2" x 10	CB-L1961	
CF85.410	10/06 -	MX300	ASTronic	AKB-L3602	430-701-L2320	430-019-L3040 2" x 10	CB-L3490	
CF85.430	01-	XE315	ZF 16S-151 ZF 16S-181 ZF 16S-221	AKB-L2008	430-701-L2320	430-019-L3040 2" x 10	CB-L1961	
CF85.460	10/06 -	MX340	Ecosplit	AKB-L3620	430-701-L2320	430-019-L2321 2" x 10	CB-L1961	
CF85.460	10/06 -	MX340	ASTronic	AKB-L3602	430-701-L2320	430-019-L3040 2" x 10	CB-L3490	
CF85.480	01-	XE355	ZF 16S-151 ZF 16S-181 ZF 16S-221	AKB-L2008	430-701-L2320	430-019-L3040 2" x 10	CB-L1961	
CF85.510	10/05 -	MX375	Ecosplit	AKB-L3620	430-701-L2320	430-019-L2321 2" x 10	CB-L1961	
CF85.510	10/05 -	MX375	ASTronic	AKB-L3602	430-701-L2320	430-019-L3040 2" x 10	CB-L3490	
95 Series								
95.500	94-97	VF373	ZF 16S-221	AKB-L2008	430-701-L2320	430-019-L3040 2" x 10	CB-L1961	
95XF SERIES								
95XF380	97-01	XF280	ZF 16S-181	AKB-L2008	430-701-L2320	430-019-L3040 2" x 10	CB-L1961	
95XF430	97-02	XF315	ZF 16S-181	AKB-L2008	430-701-L2320	430-019-L3040 2" x 10	CB-L1961	
95XF480	97-02	XF355	ZF 16S-221	AKB-L2008	430-701-L2320	430-019-L3040 2" x 10	CB-L1961	
95XF530	97-02	VF390	ZF 16S-221	AKB-L2008	430-701-L2320	430-019-L3040 2" x 10	CB-L1961	
XF95 SERIES								
XF95.380	01-	XE280	ZF 16S-151 ZF 16S-181 ZF 16S-221	AKB-L2008	430-701-L2320	430-019-L3040 2" x 10	CB-L1961	
XF95.380	01-	XE280	ZF 16S-151 ZF 16S-181 ZF 16S-221	AKB-L2008	430-701-L2320	430-019-L3040 2" x 10	CB-L1961	Xtend clutch with automatic adjustment
XF95.430	01-	XE315	ZF 16S-151 ZF 16S-181 ZF 16S-221	AKB-L2008	430-701-L2320	430-019-L3040 2" x 10	CB-L1961	
XF95.430	01-	XE315	ZF 16S-151 ZF 16S-181 ZF 16S-221	AKB-L2008	430-701-L2320	430-019-L3040 2" x 10	CB-L1961	Xtend clutch with automatic adjustment
XF95.480	01-	XE355	ZF 16S-151 ZF 16S-181 ZF 16S-221	AKB-L2008	430-701-L2320	430-019-L3040 2" x 10	CB-L1961	

 Vehicle	Year	 Engine	 Gearbox	 LIPE Kit No.	 LIPE cover	 LIPE Disc	 LIPE Bearing	Notes
DAF (INC. LEYLAND) Cont'd								
XF95.480	01-	XE355	ZF 16S-151 ZF 16S-181 ZF 16S-221	AKB-L2008	430-701-L2320	430-019-L3040 2" x 10	CB-L1961	Xtend clutch with automatic adjustment
XF95.530	01-	XE390	ZF 16S-151 ZF 16S-181 ZF 16S-221	AKB-L2008	430-701-L2320	430-019-L3040 2" x 10	CB-L1961	
XF95.530	01-	XE390	ZF 16S-151 ZF 16S-181 ZF 16S-221	AKB-L2008	430-701-L2320	430-019-L3040 2" x 10	CB-L1961	Xtend clutch with automatic adjustment
XF105 SERIES								
XF105.410	10/05 -	MX300	ZF 16S-2020 ZF 16S-2220	AKB-L3620	430-701-L2320	430-019-L2321 2" x 10	CB-L1961	
XF105.410	10/05 -	MX300	ASTronic	AKB-L3602	430-701-L2320	430-019-L3040 2" x 10	CB-L3490	
XF105.460	10/05 -	MX340	ZF 16S-2020 ZF 16S-2220	AKB-L3620	430-701-L2320	430-019-L2321 2" x 10	CB-L1961	
XF105.460	10/05 -	MX340	ASTronic	AKB-L3602	430-701-L2320	430-019-L3040 2" x 10	CB-L3490	
XF105.510	10/05 -	MX375	ZF 16S-2020 ZF 16S-2220	AKB-L3620	430-701-L2320	430-019-L2321 2" x 10	CB-L1961	
XF105.510	10/05 -	MX375	ASTronic	AKB-L3602	430-701-L2320	430-019-L3040 2" x 10	CB-L3490	
EICHER MOTORS(VECVL)								
20.15					330-061-L4003	330-009-L4002		
30.25					140-701-L2397	140-009-L2398		
30.25 FE					140-701-L2542	140-009-L2543		
15.16					330-061-L4003	330-009-L4002		
Terra 16 HDR					380-061-L2770	380-019L2771		
ERF								
E6		Cummins 6BTA	Eaton	AK-L0912				
E6		Cummins 6BTA	Eaton	AK-L0914				From Chassis 67237
EC6		Cummins 6BTA	Eaton	AK-L0913				From Chassis 72280
EC6		Cummins 6BTA	Eaton	AK-L0873				H/Duty Spec.
EC7		CAT3126 275/300	Eaton	LP-L0404AK-688				
E8		Cummins 6CTAA-240	Eaton	SP-L2352 LP1911-688				
E10		Cummins LT10250	Eaton	SP-L2580 LP1139-608				
E10		LTIA275	Eaton	SP-L2580 LP1139-608				
EC10		LTA10325	Eaton	SP-L2580 LP1139-608				
EC10		L275	Eaton	SP-L2580 LP1139-608				
EC10		L325	Eaton	SP-L2580 LP1139-608				
EC10		L350E	Eaton	SP-L2580 LP1139-608				
EC11		M305	Eaton	SP-L2332 LP-L1868AK-688		2" x 10		
EC11		M340E	Eaton	SP-L2332 LP-L1868AK-688		2" x 10		
EC11		M380E	Eaton	SP-L2332 LP-L1868AK-688		2" x 10		
EC11		M405E	Eaton	SP-L2333 LP-L1868AK-608		2" x 10		





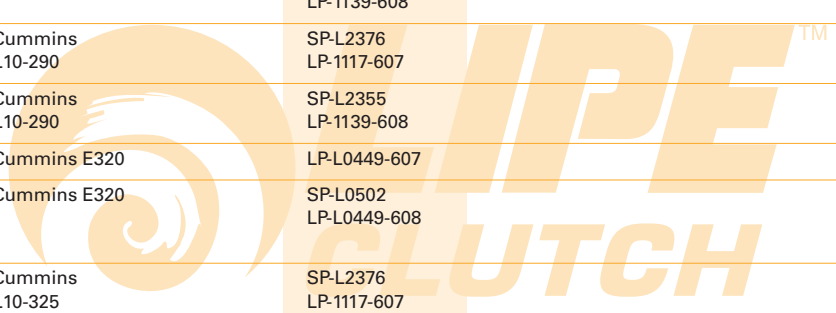

 Vehicle	Year	 Engine	 Gearbox	 LIPE Kit No.	 LIPE cover	 LIPE Disc	 LIPE Bearing	Notes
ERF Cont'd								
ECS			Eaton	SP-L2332 LP-L1868AK-688		2" x 10		
EC/ECS/ECX 11.30		Cummins M305E	Eaton	SP-L2332 LP-L1868AK-688		2" x 10		
EC/ECS/ECX 11.30		Cummins M305E		AKB-L2456	430-701-L2320	430-019-L2321 2" x 10	CB-L1961	
EC/ECS/ECX 11.34		Cummins 340E		SP-L2332 LP-L1868AK-688		2" x 10		
EC/ECS/ECX 11.34		Cummins 340E		AKB-L2456	430-701-L2320	430-019-L2321 2" x 10	CB-L1961	
EC/ECS/ECX 11.38		Cummins M380E		SP-L2332 LP-L1868AK-688		2" x 10		
EC/ECS/ECX 11.38		Cummins M380E		AKB-L2456	430-701-L2320	430-019-L2321 2" x 10	CB-L1961	
EC/ECS/ECX 11.41		Cummins M405E		SP-L2333 LP-L1868AK-608		2" x 10		
EC/ECS/ECX 11.41		Cummins M405E		AKB-L2456	430-701-L2320	430-019-L2321 2" x 10	CB-L1961	
EC/ECS/ECX 11.44		Cummins M440E		SP-L2333 LP-L1868AK-608		2" x 10		
EC/ECS/ECX 11.44		Cummins M440E		AKB-L2456	430-701-L2320	430-019-L2321 2" x 10	CB-L1961	
EC12C.36		CAT12.360		SP-L2332 LP-L1868AK-688		2" x 10		
EC12C.36		CAT12.360		AKB-L2456	430-701-L2320	430-019-L2321 2" x 10	CB-L1961	
EC12C.40		CAT12.400		SP-L2332 LP-L1868AK-688		2" x 10		
EC12C.40		CAT12.400		AKB-L2456	430-701-L2320	430-019-L2321 2" x 10	CB-L1961	
EC12C.40		CAT12.420		SP-L2333 LP-L1868AK-608		2" x 10		
EC12C.40		CAT12.420		AKB-L2456	430-701-L2320	430-019-L2321 2" x 10	CB-L1961	
EC127.41		D.DIESEL 417		SP-L2332 LP-L1868AK-688		2" x 10		
EC127.41		D.DIESEL 417		AKB-L2456	430-701-L2320	430-019-L2321 2" x 10	CB-L1961	
EC127.41		D.DIESEL 448		SP-L2333 LP-L1868AK-608		2" x 10		
EC127.41		D.DIESEL 448		AKB-L2456	430-701-L2320	430-019-L2321 2" x 10	CB-L1961	
EC127.50		D.DIESEL 507		SP-L2333 LP-L1868AK-608		2" x 10		
EC127.50		D.DIESEL 507		AKB-L2456	430-701-L2320	430-019-L2321 2" x 10	CB-L1961	
EC/ECX 14.42		Cummins N425E		SP-L2333 LP-L1868AK-608		2" x 10		
EC/ECX 14.42		Cummins N425E		AKB-L2456	430-701-L2320	430-019-L2321 2" x 10	CB-L1961	
EC/ECX 14.47		Cummins N475E		SP-L2333 LP-L1868AK-608		2" x 10		
EC/ECX 14.47		Cummins N475E		AKB-L2456	430-701-L2320	430-019-L2321 2" x 10	CB-L1961	
EC/ECX 14.52		Cummins 525E		SP-L2333 LP-L1868AK-608		2" x 10		
EC/ECX 14.52		Cummins 525E		AKB-L2456	430-701-L2320	430-019-L2321 2" x 10	CB-L1961	
EC15C.46 /55		CAT3406E		SP-L2333 LP-L1868AK-608		2" x 10		
EC15C.46 /55		CAT3406E		AKB-L2456	430-701-L2320	430-019-L2321 2" x 10	CB-L1961	
ECM 6-22				AKB-L2618	395-071-L3096	395-019-L3100 1 3/4" x 10		
ECM 7-22/28				AKB-L2618	395-071-L3096	395-019-L3100 1 3/4" x 10		

 Vehicle	Year	 Engine	 Gearbox	 LIPE Kit No.	 LIPE cover	 LIPE Disc	 LIPE Bearing	Notes
ERF Cont'd								
ECM 12.36		ZF		AKB-L2456	430-701-L2320	430-019-L2321 2" x 10	CB-L1961	
ECS 8				AKB-L2001				
ECT11.39/42		Cummins ISME 385/420		AKB-L2456	430-701-L2320	430-019-L2321 2" x 10	CB-L1961	
ECT 12.36		MAN D2866		AKB-L2456	430-701-L2320	430-019-L2321 2" x 10	CB-L1961	
ECT 13.46/48		MAN D2876/460/480		AKB-L2456	430-701-L2320	430-019-L2321 2" x 10	CB-L1961	
EC								
	93-00	Cummins M11	ZF	AKB-L2456	430-701-L2320	430-019-L2321 2" x 10	CB-L1961	
ES								
	93-00	Cummins M11	ZF	AKB-L2456	430-701-L2320	430-019-L2321 2" x 10	CB-L1961	
ECS								
	00-03	Cummins	ZF	AKB-L2456	430-701-L2320	430-019-L2321 2" x 10	CB-L1961	
ECX								
	00-03	Cummins	ZF	AKB-L2456	430-701-L2320	430-019-L2321 2" x 10	CB-L1961	
ECT								
	02-		ZF	AKB-L2456	430-701-L2320	430-019-L2321 2" x 10	CB-L1961	
480	02-		ZF 16S-181	AKB-L3611	430-701-L3610	430-019-L3611 2" x 10	CB-L1961	
FODEN								
2000 Series								
		Cummins 6BTA		AK-L0913				Check if clutch is push or pull type
		Cummins 6BTA		LP-L0480-608				Check if clutch is push or pull type
		Cummins 6BTA		AK-L2516				c/w Flywheel Saver Kit
		Cummins 6BTA		LP-L0480-608Z				
		Perkins Phaser 211		AK-L0913				
3000 & 4000 Series								
		Caterpillar 270ATAAC		SP-L2376 LP-1117-607				
		Caterpillar 270ATAAC		SP-L2355 LP-1139-608				
		Caterpillar 270DITA		SP-L2376 LP-1117-607				
		Caterpillar 270DITA		SP-L2355 LP-1139-608				
		Caterpillar 300ATAAC		LP-L0449-607				Adaptor Kit AK-10802 may be required
		Caterpillar 300ATAAC		SP-L0502 LP-L0449-608				Adaptor Kit AK-10802 may be required
		Caterpillar 350		LP-L0449-607				Adaptor Kit AK-10802 may be required
		Caterpillar 350		SP-L0502 LP-L0449-608				Adaptor Kit AK-10802 may be required
		Caterpillar 400		LP-L0449-607				Adaptor Kit AK-10802 may be required

 Vehicle	 Year	 Engine	 Gearbox	 LIPE Kit No.	 LIPE cover	 LIPE Disc	 LIPE Bearing	Notes
FODEN Cont'd								
		Caterpillar 400		SP-L0502 LP-L0449-608				Adaptor Kit AK-L0802 may be required
		Cummins 6CT 211		LP-L0404-607				Adaptor Kit AK-285 may be required
		Cummins 6CT 211		LP-L0825-608				Adaptor Kit AK-285 may be required Flat Flywheel Application
		Cummins 6CTAA265/275		SP-L2371 LP-1138-608				
		Cummins L10-250		SP-L2375 LP-1911-607				
		Cummins L10-250		SP-L2352 LP-1911-688				
		Cummins L10-250		SP-L2376 LP-1913-607				Check Spline size
		Cummins L10-250		SP-L2370 LP-1913-688				Check Spline size
		Cummins E290		SP-L2376 LP-1117-607				
		Cummins E290		SP-L2355 LP-1139-608				
		Cummins L10-290		SP-L2376 LP-1117-607				
		Cummins L10-290		SP-L2355 LP-1139-608				
		Cummins E320		LP-L0449-607				
		Cummins E320		SP-L0502 LP-L0449-608				Adaptor Kit AK-L0802 may be required
		Cummins L10-325		SP-L2376 LP-1117-607				
		Cummins L10-325		SP-L2355 LP-1139-608				
		Cummins E350		LP-L0449-607				
		Cummins E350		SP-L0502 LP-L0449-608				Adaptor Kit AK-L0802 may be required
		Cummins E400		LP-L0449-607				
		Cummins E400		SP-L0502 LP-L0449-608				Adaptor Kit AK-L0802 may be required
		Gardner 6LXDT		SP-L2376 LP-1117-607				
		Gardner 6LXDT		SP-L2355 LP-1139-608				
		RR/Perkins 265LE		SP-L2376 LP-1117-607				
		RR/Perkins 265LE		SP-L2355 LP-1139-608				
		RR/Perkins 300LE		LP-L0449-607				
		RR/Perkins 300LE		SP-L0502 LP-L0449-608				
		RR/Perkins 300TX		SP-L0502 LP-L0449-608				
		RR/Perkins 325TX		SP-L0502 LP-L0449-608				
		RR/Perkins 325LE		LP-L0449-607				
		RR/Perkins 325LE		SP-L0502 LP-L0449-608				
		RR/Perkins 350LE		LP-L0449-607				



 Vehicle	Year	 Engine	 Gearbox	 LIPE Kit No.	 LIPE cover	 LIPE Disc	 LIPE Bearing	Notes
		RR/Perkins 350LE		SP-L0502 LP-L0449-608				
		RR/Perkins TX365		SP-L0502 LP-L0449-608				
2000-Alpha								
		Cummins B215/ 180/ 210		LP-L0480-608				Flat Flywheel application
		Cummins B215/ 180/ 210		AKB-L2516				c/w Flywheel Saver Kit
		Caterpillar 3126/B-275/ 300		LP-L0404AK-688				Flat Flywheel application
		Cummins C280		LP-L0404AK-688				Flat Flywheel application
		Cummins C280		LP-L0404AK-688				Flat Flywheel application
		Cummins C245		LP-L0404AK-688				Flat Flywheel application
		Cummins C300		LP-L0404AK-688				Flat Flywheel application
		Cummins M305E		SP-L2332 LP-L1868AK-688		2" x 10		Solo type option SP-L2566
		Cummins M305E		AKB-L2456	430-701-L2320	430-019-L2321 2" x 10	CB-L1961	
		Cummins M340E		SP-L2332 LP-L1868AK-688		2" x 10		Solo type option SP-L2566
		Cummins M340E		AKB-L2456	430-701-L2320	430-019-L2321 2" x 10	CB-L1961	
		Cummins M380E		SP-L2332 LP-L1868AK-688		2" x 10		Solo type option SP-L2566
		Cummins M380E		AKB-L2456	430-701-L2320	430-019-L2321 2" x 10	CB-L1961	
		Cummins M405E		SP-L2333 LP-L1868AK-608		2" x 10		Solo type option SP-L2566
		Cummins M405E		AKB-L2534				
		Caterpillar 3126/B-275		LP-L0404AK-688				Flat Flywheel application
		Caterpillar C-10 325		SP-L2332 LP-L1868AK-688		2" x 10		Solo type option SP-L2566
		Caterpillar C-10 325		AKB-L2456	430-701-L2320	430-019-L2321 2" x 10	CB-L1961	
		Caterpillar C-10 340		SP-L2332 LP-L1868AK-688		2" x 10		Solo type option SP-L2566
		Caterpillar C-10 340		AKB-L2456	430-701-L2320	430-019-L2321 2" x 10	CB-L1961	
		Caterpillar C-10 350		SP-L2332 LP-L1868AK-688		2" x 10		Solo type option SP-L2566
		Caterpillar C-10 350		AKB-L2456	430-701-L2320	430-019-L2321 2" x 10	CB-L1961	
		Caterpillar C-10 365		SP-L2332 LP-L1868AK-688		2" x 10		Solo type option SP-L2566
		Caterpillar C-10 365		AKB-L2456	430-701-L2320	430-019-L2321 2" x 10	CB-L1961	
		Caterpillar C-10 380		SP-L2332 LP-L1868AK-688		2" x 10		Solo type option SP-L2566
		Caterpillar C-10 380		AKB-L2456	430-701-L2320	430-019-L2321 2" x 10	CB-L1961	
		Caterpillar C-12 400		LP-L1868AK-688		2" x 10		
		Caterpillar C-10 400		AKB-L2456	430-701-L2320	430-019-L2321 2" x 10	CB-L1961	
A2-4R								
		Cummins CE185,220,250		AKB-L2618	395-071-L3096	395-019-L3100 1 3/4" x 10		

 Vehicle	Year	 Engine	 Gearbox	 LIPE Kit No.	 LIPE cover	 LIPE Disc	 LIPE Bearing	Notes
FODEN Cont'd								
A3-4T								
		Caterpillar C12 345,400		AKB-L2456	430-701-L2320	430-019-L2321 2" x 10	CB-L1961	
		Cummins ISME345, 385, 420		AKB-L2456	430-701-L2320	430-019-L2321 2" x 10	CB-L1961	
A3-6R								
		Caterpillar 3126E, 280, 305		AKB-L2456	430-701-L2320	430-019-L2321 2" x 10	CB-L1961	
		Caterpillar C12, 345, 400		AKB-L2456	430-701-L2320	430-019-L2321 2" x 10	CB-L1961	
A3-6M								
		Caterpillar ISME345, 385		AKB-L2456	430-701-L2320	430-019-L2321 2" x 10	CB-L1961	
Cummins		AKB-L2456 ISME, 345, 385, 420 345/420ESP	430-701-L2320	430-019-L2321		2" x 10	CB-L1961	
A3-CT								
CT.T		Caterpillar C12 400		AKB-L2456	430-701-L2320	430-019-L2321 2" x 10	CB-L1961	
		Caterpillar C12 450		AKB-L2456	430-701-L2320	430-019-L2321 2" x 10	CB-L1961	
A3-CT.T								
A3-6T		Cummins ISME 385, 420, 345 420ESP		AKB-L2456	430-701-L2320	430-019-L2321 2" x 10	CB-L1961	
A3-8R								
		Caterpillar C12 345, 400		AKB-L2456	430-701-L2320	430-019-L2321 2" x 10	CB-L1961	
		Cummins ISME 345, 385		AKB-L2456	430-701-L2320	430-019-L2321 2" x 10	CB-L1961	
3000								
	91-	Perkins	Eaton	AKB-L2456	430-701-L2320	430-019-L2321 2" x 10	CB-L1961	
4000								
	91-	Perkins	Eaton	AKB-L2456	430-701-L2320	430-019-L2321 2" x 10	CB-L1961	
GOLDEN DRAGON CHINA								
XMQ 6110		Cummins 6CTA 8.3			380 061 L1166	380 009 L0235 1 3/4" x 10		
HINO								
FS2P								
	96-	P11C-TE	ZF 16S-151	AKB-L2854				
FY2P								
	96-	P11C-TE	ZF 16S-151	AKB-L2854				
F700 SERIES								
F700 SERIES	06-	E13C	ZF 16S-221	AKB-L3038	430-701-L2320	430-019-L3551 2" x 10	CB-L1961	
IVECO FORD								
Cargo								
1218		Cummins 6BTA		AK-L0914				Adaptor Kit AK-313 may be required. Also CB- L0696R release bearing and carrier



Vehicle

Year



Engine



Gearbox



LIPE Kit No.



LIPE cover



LIPE Disc



LIPE Bearing

Notes

IVECO FORD Cont'd

1318		Cummins 6BTA		AK-L0914				Adaptor Kit AK-313 may be required. Also CB-L0696R release bearing and carrier
1418		Cummins 6BTA		AK-L0914				Adaptor Kit AK-313 may be required. Also CB-L0696R release bearing and carrier
1718		Cummins 6BTA		AK-L0914				Adaptor Kit AK-313 may be required. Also CB-L0696R release bearing and carrier
1718		Cummins 6BTA		LP-L0697-644				Adaptor Kit AK-313 may be required. Also CB-L0696R release bearing and carrier
1721		Cummins 6CT		LP-L0692-607				
2421		Cummins 6CT		LP-L0692-608				

Cargo

0915	81- -01/85	365 6.0L 380 6.2L		AK-L0815				
1115	81- -01/85	365 6.0L 380 6.2L		AK-L0815				
1315	81- -01/85	365 6.0L 380 6.2L		AKB-L2273				
2014	81- -01/85	365 6.0L 380 6.2L		AK-L0815				
2015	81- -01/85	365 6.0L 380 6.2L		AK-L0816				

Eurocargo

75E15	91-01	8060		AKB-L1826				
80E15	91-01	8060		AKB-L1826				
80E18	91-01	8060		AKB-L1826				
80E21	96-01	8060		AKB-L3173				
95E15	95-01	8060		AKB-L1826				
95E21	95-01	8060		AKB-L3173				
110E15	91-01	8060		AKB-L1826				
100E18	91-01	8060		AKB-L1826				
100E21	96-01	8060		AKB-L3173				
110E15	92-01	8060		AKB-L1826				
110E18	92-01	8060		AKB-L1826				
120E15	92-01	8060		AKB-L1826				
120E18	92-01	8060		AKB-L1826				
120E23	95-96	8060		AKB-L3173				
130E15	92-01	8060		AKB-L1826				
130E18	92-01	8060		AKB-L1826				
135E18	95-01	8060		AKB-L1826				
135E23	95-01	8060		AKB-L3173				
140E15	92-01	8060		AKB-L1826				
140E18	92-01	8060		AKB-L1826				
140E23	98-01	8060		AKB-L3173				
150E15	92-01	8060		AKB-L1826				
150E18	92-01	8060		AKB-L1826				
150E23	97-01	8060		AKB-L3173				
170E15	93-96	8060		AKB-L1826				
170E18	93-96	8060		AKB-L1826				



Vehicle



Year

Engine



Gearbox



LIPE Kit No.



LIPE cover



LIPE Disc

LIPE
Bearing

Notes

IVECO FORD Cont'd









170E23	93-01	8060		AKB-L3173				
180E18	96-01	8060		AKB-L1826				
180E21	91-01	8060		AKB-L3173				
180E23	96-01	8060		AKB-L3173				
210E23	92-01	8060		AKB-L3173				
250E23	92-01	8060		AKB-L3173				
260E23	95-96	8060		AKB-L3173				
260E27	93-00	8360		AKB-L2619				
320E27	92-01	8360		AKB-L2619				

Eurocargo Tector









65E15	01-03	E0481C	Iveco 2855.5 Iveco 2855.6	AKB-L3173				
75E17	01-03	E0481A	Iveco 2855.5 Iveco 2855.6	AKB-L3173				
80E18	01-03	E0681E	Iveco 2870.9	AKB-L2511				
80E21	01-03	E0681D	Iveco 2865.6 Iveco 2870.9	AKB-L2511				
100E17	02-03	E0481A E0481D	Iveco 2855.6	AKB-L3173				
100E17	02-03	E0481A E0481D	Iveco 2870.9	AKB-L2511				
100E21	02-03	E0681C E0681D	Iveco 2865.6	AKB-L2511				
120EL17	01-03	E0481A E0481D	Iveco 2855.6	AKB-L3173				
120EL17	01-03	E0481A E0481D	Iveco 2870.9	AKB-L2511				
120E18	01-03	E0681E	Iveco 2855.6	AKB-L3173				
120E18	01-03	E0681E	Iveco 2870.9	AKB-L2511				
130E18	01-03	E0681E	Iveco 2855.6	AKB-L3173				
130E18	01-03	E0681E	Iveco 2870.9	AKB-L2511				
140E18	02-03	E0681E	Iveco 2855.6	AKB-L2511				
150E18	01-03	E0681E	Iveco 2865.6 Iveco 2870.9	AKB-L2511				
180E21	01-03	E0681D	Iveco 2865.6 Iveco 2870.9	AKB-L2511				

New Eurocargo Tector

65E15	03-	E0481C	Iveco 2855.5 Iveco 2855.6	AKB-L3173				
75E17	03-	E0481A	Iveco 2855.5 Iveco 2855.6	AKB-L3173				
80E17	03-	E0481A	Iveco 2855.6	AKB-L3173				
80E17	03-	E0481A	Iveco 2870.9	AKB-L2511				
80E18	03-	E0681E	Iveco 2870.9	AKB-L2511				
80E21	03-	E0681D	Iveco 2865.6 Iveco 2870.9	AKB-L2511				
100E17	03-	E0481A	Iveco 2855.6	AKB-L3173				
100E17	03-	E0481A	Iveco 2870.9	AKB-L2511				
100E18	03-	E0681E	Iveco 2855.6	AKB-L3173				
100E18	03-	E0681E	Iveco 2870.9	AKB-L2511				
100E21	03-	E0681D	Iveco 2865.6 Iveco 2870.9	AKB-L2511				
120EL17	03-	E0481A	Iveco 2855.6	AKB-L3173				
120EL17	03-	E0481A	Iveco 2870.9	AKB-L2511				
120E18	03-	E0681E	Iveco 2855.6	AKB-L2613				
120E18	03-	E0681E	Iveco 2870.9	AKB-L2511				
120EL21	03-	E0681D	Iveco 2865.6 Iveco 2870.9	AKB-L2511				
130E18	03-	E0681E	Iveco 2855.6	AKB-L3173				

 Vehicle	 Year	 Engine	 Gearbox	 LIPE Kit No.	 LIPE cover	 LIPE Disc	 LIPE Bearing	Notes
IVECO FORD Cont'd								
130E18	03-	E0681E	Iveco 2870.9	AKB-L2511				
130E21	03-	E0681D	Iveco 2865.6 Iveco 2870.9	AKB-L2511				
140E18	03-	E0681E	Iveco 2855.6	AKB-L2511				
150E21	03-	E0681D	Iveco 2865.6 Iveco 2870.9	AKB-L2511				
180E21	03-	E0681D	Iveco 2865.6 Iveco 2870.9	AKB-L2511				
Eurostar								
180E42	96-98	8210	Eaton	AKB-L2012	430-701-L2320	430-019-L3040 2" x 10	CB-L1339	
180E42	96-98	8210	ZF	AKB-L2011	430-701-L2320	430-019-L2321 2" x 10	CB-L1339	
240E42	98-00	8210	Eaton	AKB-L2012	430-701-L2320	430-019-L3040 2" x 10	CB-L1339	
240E42	98-00	8210	ZF	AKB-L2011	430-701-L2320	430-019-L2321 2" x 10	CB-L1339	
400E42	95-00	8210	Eaton	AKB-L2012	430-701-L2320	430-019-L3040 2" x 10	CB-L1339	
400E42	95-00	8210	ZF	AKB-L2011	430-701-L2320	430-019-L2321 2" x 10	CB-L1339	
400E47	97-	8210	Eaton TS166-12	AKB-L2012	430-701-L2320	430-019-L3040 2" x 10	CB-L1339	
400E47	97-	8210	ZF 16S-221 ZF 16AS2200	AKB-L2011	430-701-L2320	430-019-L2321 2" x 10	CB-L1339	
400E52	95-00	8280	Eaton TS166-12	AKB-L2012	430-701-L2320	430-019-L3040 2" x 10	CB-L1339	
400E52	95-00	8280	ZF 16S-221	AKB-L2011	430-701-L2320	430-019-L2321 2" x 10	CB-L1339	
Eurostar Cursor								
180E39	98-02	E0681E	ZF	AKB-L2011	430-701-L2320	430-019-L2321 2" x 10	CB-L1339	
180E43	98-02	E0681E	ZF	AKB-L2011	430-701-L2320	430-019-L2321 2" x 10	CB-L1339	
190E39	98-02	E0681E	ZF	AKB-L2011	430-701-L2320	430-019-L2321 2" x 10	CB-L1339	
190E43	98-02	E0681E	ZF	AKB-L2011	430-701-L2320	430-019-L2321 2" x 10	CB-L1339	
240E39	98-02	E0681E	ZF	AKB-L2011	430-701-L2320	430-019-L2321 2" x 10	CB-L1339	
240E43	98-02	E0681E	ZF	AKB-L2011	430-701-L2320	430-019-L2321 2" x 10	CB-L1339	
260E39	98-02	E0681E	ZF	AKB-L2011	430-701-L2320	430-019-L2321 2" x 10	CB-L1339	
260E43	98-02	E0681E	ZF	AKB-L2011	430-701-L2320	430-019-L2321 2" x 10	CB-L1339	
400E39	98-02	E0681E	ZF	AKB-L2011	430-701-L2320	430-019-L2321 2" x 10	CB-L1339	
400E43	98-02	E0681E	ZF	AKB-L2011	430-701-L2320	430-019-L2321 2" x 10	CB-L1339	
440E39	98-02	E0681E	ZF	AKB-L2011	430-701-L2320	430-019-L2321 2" x 10	CB-L1339	
440E40	98-02	E0681B	ZF 12AS2301	AKB-L2011	430-701-L2320	430-019-L2321 2" x 10	CB-L1339	
440E43	98-02	E0681E	ZF	AKB-L2011	430-701-L2320	430-019-L2321 2" x 10	CB-L1339	
Eurotech								
180E42	96-00	8210	Eaton	AKB-L2012	430-701-L2320	430-019-L3040 2" x 10	CB-L1339	
180E42	96-00	8210	ZF	AKB-L2011	430-701-L2320	430-019-L2321 2" x 10	CB-L1339	
240E42	97-00	8210	Eaton	AKB-L2012	430-701-L2320	430-019-L3040 2" x 10	CB-L1339	

 Vehicle	 Year	 Engine	 Gearbox	 LIPE Kit No.	 LIPE cover	 LIPE Disc	 LIPE Bearing	Notes
IVECO FORD Cont'd								
240E42	97-00	8210	ZF	AKB-L2011	430-701-L2320	430-019-L2321 2" x 10	CB-L1339	
400E42	92-00	8210	Eaton	AKB-L2012	430-701-L2320	430-019-L3040 2" x 10	CB-L1339	
400E42	92-00	8210	ZF	AKB-L2011	430-701-L2320	430-019-L2321 2" x 10	CB-L1339	
440E42	94-96	8210	Eaton	AKB-L2012	430-701-L2320	430-019-L3040 2" x 10	CB-L1339	
440E42	94-96	8210	ZF	AKB-L2011	430-701-L2320	430-019-L2321 2" x 10	CB-L1339	
Eurotech Cursor								
190E39	98-02	E0681E	ZF 16S-151 ZF 12AS1800	AKB-L2011	430-701-L2320	430-019-L2321 2" x 10	CB-L1339	
190E43	98-02	E0681D	ZF 16S-181 ZF 16S-221	AKB-L2011	430-701-L2320	430-019-L2321 2" x 10	CB-L1339	
260E39	98-02	E0681E	ZF	AKB-L2011	430-701-L2320	430-019-L2321 2" x 10	CB-L1339	
260E43	98-02	E0681D	ZF	AKB-L2011	430-701-L2320	430-019-L2321 2" x 10	CB-L1339	
400E39	99-02	E0681E	ZF	AKB-L2011	430-701-L2320	430-019-L2321 2" x 10	CB-L1339	
400E43	99-02	E0681D	ZF	AKB-L2011	430-701-L2320	430-019-L2321 2" x 10	CB-L1339	
440E39	99-02	E0681E	ZF	AKB-L2011	430-701-L2320	430-019-L2321 2" x 10	CB-L1339	
440E43	99-02	E0681D	ZF	AKB-L2011	430-701-L2320	430-019-L2321 2" x 10	CB-L1339	
Eurotrakker								
340E37	94-01	8210	Eaton	AKB-L2012	430-701-L2320	430-019-L3040 2" x 10	CB-L1339	
340E37	94-01	8210	ZF	AKB-L2011	430-701-L2320	430-019-L2321 2" x 10	CB-L1339	
Eurotrakker Cursor								
340E38	98-02	E0681G	ZF 16S-151 ZF 12AS2601	AKB-L2011	430-701-L2320	430-019-L2321 2" x 10	CB-L1339	
340E44	98-02	E0681C	ZF 16S-181 ZF 12AS2601	AKB-L2011	430-701-L2320	430-019-L2321 2" x 10	CB-L1339	
410E44	98-02	E0681C	ZF 16S-181 ZF 12AS2601	AKB-L2011	430-701-L2320	430-019-L2321 2" x 10	CB-L1339	
720E48	98-02	E0681E	ZF 16S-221	AKB-L2011	430-701-L2320	430-019-L2321 2" x 10	CB-L1339	
Stralis Active Day								
AD 190 S 33	12/06-	F2BE3681	12AS-1420TD 12AS-1930TD	AKB-L3608	430-701-L2320	430-019-L2321 2" x 10	CB-L3490	
AD 190 S 36	06/03-	F2BE3681	12AS-1420TD 12AS-1930TD	AKB-L3608	430-701-L2320	430-019-L2321 2" x 10	CB-L3490	
AD 190S 40	03-	E0681B	ZF 16S181	AKB-L2011	430-701-L2320	430-019-L2321 2" x 10	CB-L1339	
AD 190 S 42	12/06-	F2BE3681	12AS-1420TD 12AS-1930TD	AKB-L3608	430-701-L2320	430-019-L2321 2" x 10	CB-L3490	
AD 190 S 43	03-	E0681D	ZF 16S181	AKB-L2011	430-701-L2320	430-019-L2321 2" x 10	CB-L1339	
AD 190 S 45	12/06-	F2BE3681	12AS-1420TD 12AS-1930TD	AKB-L3608	430-701-L2320	430-019-L2321 2" x 10	CB-L3490	
AD 260 S 40	03-	E0681B	ZF 16S181	AKB-L2011	430-701-L2320	430-019-L2321 2" x 10	CB-L1339	
AD 260 S 43	03-	E0681D	ZF 16S181	AKB-L2011	430-701-L2320	430-019-L2321 2" x 10	CB-L1339	
AD 440 S 40	03-	E0681B	ZF 16S181 ZF12AS2301	AKB-L2011	430-701-L2320	430-019-L2321 2" x 10	CB-L1339	
AD 440 S 43	03-	E0681D	ZF 16S181 ZF12AS2301	AKB-L2011	430-701-L2320	430-019-L2321 2" x 10	CB-L1339	

 Vehicle	 Year	 Engine	 Gearbox	 LIPE Kit No.	 LIPE cover	 LIPE Disc	 LIPE Bearing	Notes
IVECO FORD Cont'd								
Stralis Active Space								
AS 260 S 40	02-	E0681B	ZF 16S181 ZF12AS2301	AKB-L2011	430-701-L2320	430-019-L2321 2" x 10	CB-L1339	
AS 260 S 43	02-	E0681D	ZF 16S181 ZF12AS2301	AKB-L2011	430-701-L2320	430-019-L2321 2" x 10	CB-L1339	
AS 260 S 48	02-	E0681E	ZF 16S221 ZF 16AS2601	AKB-L2011	430-701-L2320	430-019-L2321 2" x 10	CB-L1339	
AS 440 S 40	02-	E0681B	ZF 16S181 ZF12AS2301	AKB-L2011	430-701-L2320	430-019-L2321 2" x 10	CB-L1339	
AS 440 S 43	02-	E0681D	ZF 16S181 ZF12AS2301	AKB-L2011	430-701-L2320	430-019-L2321 2" x 10	CB-L1339	
AS 440 S 48	02-	E0681E	ZF 16S221 ZF 16AS2601	AKB-L2011	430-701-L2320	430-019-L2321 2" x 10	CB-L1339	
AS 440 S 54	02-	E0681A	ZF 16S221 ZF 16AS2601	AKB-L2011	430-701-L2320	430-019-L2321 2" x 10	CB-L1339	
Stralis Active Time								
AT 190 S 33	12/06-	F2BE3681	12AS-1420TD 12AS-1930TD	AKB-L3608	430-701-L2320	430-019-L2321 2" x 10	CB-L3490	
AT 190 S 35	03-	E0681A	ZF 16S151	AKB-L2681			CB-L1339	
AT 190 S 36	12/06-	F2BE3681	12AS-1420TD 12AS-1930TD	AKB-L3608	430-701-L2320	430-019-L2321 2" x 10	CB-L3490	
AT 190 S 40	03-	E0681B	ZF 16S181	AKB-L2011	430-701-L2320	430-019-L2321 2" x 10	CB-L1339	
AT 190 S 42	12/06-	F2BE3681	12AS-1420TD 12AS-1930TD	AKB-L3608	430-701-L2320	430-019-L2321 2" x 10	CB-L3490	
AT 190 S 43	03-	E0681D	ZF 16S181	AKB-L2011	430-701-L2320	430-019-L2321 2" x 10	CB-L1339	
AT 190 S 45	12/06-	F2BE3681	12AS-1420TD 12AS-1930TD	AKB-L3608	430-701-L2320	430-019-L2321 2" x 10	CB-L3490	
AT 260 S 40	03-	E0681B	ZF 16S181	AKB-L2011	430-701-L2320	430-019-L2321 2" x 10	CB-L1339	
AT 260 S 43	03-	E0681D	ZF 16S181	AKB-L2011	430-701-L2320	430-019-L2321 2" x 10	CB-L1339	
AT 440 S 40	03-	E0681B	ZF 16S181 ZF12AS2301	AKB-L2011	430-701-L2320	430-019-L2321 2" x 10	CB-L1339	
AT 440 S 43	03-	E0681D	ZF 16S181 ZF12AS2301	AKB-L2011	430-701-L2320	430-019-L2321 2" x 10	CB-L1339	
AT 440 S 45	12/06-	F2BE3681	12AS-1420TD 12AS-1930TD	AKB-L3608	430-701-L2320	430-019-L2321 2" x 10	CB-L3490	
190.48Turbostar	89-93		ZF	AKB-L2011	430-701-L2320	430-019-L2321 2" x 10	CB-L1339	
190.48Turbostar	89-93		Fuller	AKB-L2012	430-701-L2320	430-019-L3040 2" x 10	CB-L1339	

LEYLAND DAF UK

Constructor 6	DAF 8 2/8		LP-L0404-607					Flat Flywheel Application Adaptor Kit AK-L0974 may be required
Constructor 6	DAF 8 2/8		LP-L0404-688					Adaptor Kit AK-L0974 may be required
Constructor 8	Gardner 6LXCT		SP-L2375 LP-1911-607					
Constructor 8	Gardner 6LXCT		SP-L2352 LP-1911-688					
Constructor 8	Leyland TL11 A.B.C.		SP-L2375 LP-1911-607					
Constructor 8	Leyland TL11 A.B.C.		SP-L2352 LP-1911-688					
Constructor 8 Application	Leyland		LP-L0480-608					Flat Flywheel
Constructor 8	RR/Perkins 265Lis		SP-L2375 LP-1911-607					

 Vehicle	 Year	 Engine	 Gearbox	 LIPE Kit No.	 LIPE cover	 LIPE Disc	 LIPE Bearing	Notes
LEYLAND DAF UK Cont'd								
Constructor 8		RR/Perkins 265Lis		SP-L2352 LP-1911-688				
Cruiser		Leyland TL11 A.B.C.		SP-L2375 LP-1911-607				
Cruiser		Leyland TL11 A.B.C.		SP-L2352 LP-1911-688				
Landtrain		Cummins NHC250		SP-L2374 LP-1138-607				
Landtrain		Cummins NHC250		SP-L2371 LP-1138-608				
Landtrain		Cummins E290		SP-L2374 LP-1138-607				
Landtrain		Cummins E290		SP-L2371 LP-1138-608				
Roadtrain		Cummins L10-250		SP-L2352 LP-1911-688				
Roadtrain		Cummins E290		SP-L2371 LP-1138-608				
Roadtrain		Cummins L10-290		SP-L2352 LP-1911-688				
Roadtrain		Cummins E320		SP-L0502 LP-L0449-608				SPICER gearbox only
Roadtrain		Cummins E320		SP-L0502 LP-L0449-607				Eaton gearbox (single plate HD)
Roadtrain		Cummins E350		SP-L0502 LP-L0449-608				SPICER gearbox only
Roadtrain		Leyland TL12		SP-L2374 LP-1138-607				
Roadtrain		RR/Perkins 265Lis		SP-L2352 LP-1911-688				
Roadtrain		RR/Perkins 300Li		SP-L2371 LP-1138-608				
Roadtrain		RR/Perkins 300Li		SP-L2355 LP-1139-608				
Roadtrain		RR/Perkins 340Li		SP-L2371 LP-1138-608				
FAT70-270		DAF HT168.8.25		LP-L0404-607				Adaptor Kit AK-L0974 may be required
FAT70-270		DAF 230 Turbo		LP-L0404-607				Flat Flywheel Application Adaptor Kit AK-L0974 may be required
FAD80-250		Cummins L10-250		SP-L2352 LP-1911-688				
FAD80-270		RR/Perkins 270T		LP-L0565-608				
FAD80-270		RR/Perkins 270T		SP-L2370 LP-1913-688				
Tiger & Royal		Leyland TL11 A.B.C.		SP-L2371 LP-1138-608				
Tiger		Cummins L10-250		SP-L2371 LP-1138-608				
LUCASSEN YOUNG								
C4105 Buggi		J. Deere 4039T		LP-L0471-636				
C4105 Buggi		J. Deere 4045T		LP-L0471-636				
Veg. Harvester		J. Deere 4045T		LP-L0471-646				



Vehicle

Year



Engine



Gearbox



LIPE Kit No.



LIPE cover



LIPE Disc

LIPE
Bearing

Notes

MACK TRUCK USA

Vehicle	Year	Engine	Gearbox	LIPE Kit No.	LIPE cover	LIPE Disc	LIPE Bearing	Notes
Series 400,487		Caterpillar		LP-L1138-607				
Series 400,487		Caterpillar		LP-L1138-608				
Series 600-900		Caterpillar		LP-L1138-607				
Series 600-900		Detroit Diesel		LP-L1138-608				
Series 600-900		Caterpillar		LP-L1139-607				
Series 600-900		Detroit Diesel		LP-L1139-608				

MAN**F90**

16.332	86-92	D2866LF		AKB-L2007	430-701-L2320	430-019-L2321 2" x 10	CB-L1961	
16.362	86-87	D2866KF		AKB-L2007	430-701-L2320	430-019-L2321 2" x 10	CB-L1961	
17.292	88-90	D2866LFZ		AKB-L2007	430-701-L2320	430-019-L2321 2" x 10	CB-L1961	
17.322	90-95	D2866LF		AKB-L2007	430-701-L2320	430-019-L2321 2" x 10	CB-L1961	
17.332	88-90	D2866LF		AKB-L2007	430-701-L2320	430-019-L2321 2" x 10	CB-L1961	
17.362	88-90	D2866KF		AKB-L2007	430-701-L2320	430-019-L2321 2" x 10	CB-L1961	
17.372	90-96	D2866LF		AKB-L2007	430-701-L2320	430-019-L2321 2" x 10	CB-L1961	
17.422	90-95	D2866LF		AKB-L2007	430-701-L2320	430-019-L2321 2" x 10	CB-L1961	
17.502	90-96	D2866LF		AKB-L2007	430-701-L2320	430-019-L2321 2" x 10	CB-L1961	
19.322	90-96	D2866LF03 D2866LF06		AKB-L2006	430-701-L2320	430-019-L2321 2" x 10	CB-L1961	
19.362	86-90	D2866KF D2866LU		AKB-L2007	430-701-L2320	430-019-L2321 2" x 10	CB-L1961	
22.292	88-90	D2866F		AKB-L2007	430-701-L2320	430-019-L2321 2" x 10	CB-L1961	
22.322	90-96	D2865LF		AKB-L2007	430-701-L2320	430-019-L2321 2" x 10	CB-L1961	
22.332	88-90	D2866LFZ		AKB-L2007	430-701-L2320	430-019-L2321 2" x 10	CB-L1961	
22.362	88-90	D2866LF		AKB-L2007	430-701-L2320	430-019-L2321 2" x 10	CB-L1961	
22.372	90-96	D2866LF		AKB-L2007	430-701-L2320	430-019-L2321 2" x 10	CB-L1961	
22.422	90-96	D2866LF		AKB-L2007	430-701-L2320	430-019-L2321 2" x 10	CB-L1961	
23.372	93-95	D2866LF		AKB-L2007	430-701-L2320	430-019-L2321 2" x 10	CB-L1961	
26.372	90-96	D2866LF		AKB-L2007	430-701-L2320	430-019-L2321 2" x 10	CB-L1961	
26.422	90-96	D2866LF		AKB-L2007	430-701-L2320	430-019-L2321 2" x 10	CB-L1961	
30.292	89-92	D2866LF		AKB-L2007	430-701-L2320	430-019-L2321 2" x 10	CB-L1961	
30.332	89-92	D2866LF		AKB-L2007	430-701-L2320	430-019-L2321 2" x 10	CB-L1961	
32.322	92-96	D2866LF		AKB-L2007	430-701-L2320	430-019-L2321 2" x 10	CB-L1961	
32.332	85-96	D2866LF08		AKB-L2007	430-701-L2320	430-019-L2321 2" x 10	CB-L1961	
32.372	91-96	D2866LF		AKB-L2007	430-701-L2320	430-019-L2321 2" x 10	CB-L1961	
32.422	90-96	D2866LF		AKB-L2007	430-701-L2320	430-019-L2321 2" x 10	CB-L1961	
32.502	90-96	D2866LF		AKB-L2007	430-701-L2320	430-019-L2321 2" x 10	CB-L1961	



Vehicle

Year



Engine



Gearbox



LIPE Kit No.



LIPE cover



LIPE Disc

LIPE
Bearing

Notes

MAN Cont'd

F2000

Vehicle	Year	Engine	Gearbox	LIPE Kit No.	LIPE cover	LIPE Disc	LIPE Bearing	Notes
18.323	95-99	D2865LF23		AKB-L2006	430-701-L2320	430-019-L2321 2" x 10	CB-L1961	
18.343	95-99	D2865LF21		AKB-L2006	430-701-L2320	430-019-L2321 2" x 10	CB-L1961	
18.373	95-96	D2866LF		AKB-L2007	430-701-L2320	430-019-L2321 2" x 10	CB-L1961	
18.403	95-99	D2866LF20		AKB-L2007	430-701-L2320	430-019-L2321 2" x 10	CB-L1961	
18.423	95-96	D2866LF		AKB-L2007	430-701-L2320	430-019-L2321 2" x 10	CB-L1961	
18.463	95-99	D2866LF		AKB-L2007	430-701-L2320	430-019-L2321 2" x 10	CB-L1961	
19.364	99-01	D2866LF35		AKB-L2007	430-701-L2320	430-019-L2321 2" x 10	CB-L1961	
19.403	94-	D2866LF		AKB-L2007	430-701-L2320	430-019-L2321 2" x 10	CB-L1961	
19.414	99-	D2876LF06		AKB-L2007	430-701-L2320	430-019-L2321 2" x 10	CB-L1961	
19.464	96-	D2876LF06		AKB-L2007	430-701-L2320	430-019-L2321 2" x 10	CB-L1961	
22.323	95-	D2865LF23		AKB-L2006	430-701-L2320	430-019-L2321 2" x 10	CB-L1961	
22.343	95-99	D2865LF21		AKB-L2006	430-701-L2320	430-019-L2321 2" x 10	CB-L1961	
22.373	95-	D2866		AKB-L2007	430-701-L2320	430-019-L2321 2" x 10	CB-L1961	
22.403	95-99	D2866LF20		AKB-L2007	430-701-L2320	430-019-L2321 2" x 10	CB-L1961	
22.423	95-	D2876		AKB-L2007	430-701-L2320	430-019-L2321 2" x 10	CB-L1961	
23.463	95-99	D2876LF02		AKB-L2007	430-701-L2320	430-019-L2321 2" x 10	CB-L1961	
23.364	99	D2865LF		AKB-L2006	430-701-L2320	430-019-L2321 2" x 10	CB-L1961	
23.373	95-97	D2866LF		AKB-L2007	430-701-L2320	430-019-L2321 2" x 10	CB-L1961	
23.403	95-99	D2866LF20		AKB-L2007	430-701-L2320	430-019-L2321 2" x 10	CB-L1961	
23.414	99	D2866LF31		AKB-L2007	430-701-L2320	430-019-L2321 2" x 10	CB-L1961	
23.464	99	D2866LF		AKB-L2007	430-701-L2320	430-019-L2321 2" x 10	CB-L1961	
26.343	95-	D2865LF		AKB-L2006	430-701-L2320	430-019-L2321 2" x 10	CB-L1961	
26.364	99-01	D2866LF35		AKB-L2007	430-701-L2320	430-019-L2321 2" x 10	CB-L1961	
26.414	99-	D2866LF31		AKB-L2007	430-701-L2320	430-019-L2321 2" x 10	CB-L1961	
26.464	99-	D2876LF06		AKB-L2007	430-701-L2320	430-019-L2321 2" x 10	CB-L1961	
32.343	95-99	D2866LF21		AKB-L2006	430-701-L2320	430-019-L2321 2" x 10	CB-L1961	
32.364	99-01	D2866LF35		AKB-L2006	430-701-L2320	430-019-L2321 2" x 10	CB-L1961	
32.403	96-97	D2866LF		AKB-L2007	430-701-L2320	430-019-L2321 2" x 10	CB-L1961	
33.403	97-99	D2866LF		AKB-L2007	430-701-L2320	430-019-L2321 2" x 10	CB-L1961	
33.414	99-01	D2866LF31		AKB-L2007	430-701-L2320	430-019-L2321 2" x 10	CB-L1961	
33.463	97-99	D2866LF		AKB-L2007	430-701-L2320	430-019-L2321 2" x 10	CB-L1961	
33.464	99-01	D2876LF		AKB-L2007	430-701-L2320	430-019-L2321 2" x 10	CB-L1961	

 Vehicle	 Year	 Engine	 Gearbox	 LIPE Kit No.	 LIPE cover	 LIPE Disc	 LIPE Bearing	Notes
MAN Cont'd								
35.343	95-99	D2865LF21		AKB-L2006	430-701-L2320	430-019-L2321 2" x 10	CB-L1961	
35.364	99-03	D2866LF35		AKB-L2007	430-701-L2320	430-019-L2321 2" x 10	CB-L1961	
35.403	95-99	D2866LF21		AKB-L2007	430-701-L2320	430-019-L2321 2" x 10	CB-L1961	
35.414	99-03	D2866LF31		AKB-L2007	430-701-L2320	430-019-L2321 2" x 10	CB-L1961	
L2000								
7.153	04/96 -97	D0824LFL	ZF S5-42	AKB-L2018		362-019-L3131 1 1/2" x 10		
8.153	04/96-	D0824LFL	ZF S5-42	AKB-L2018		362-019-L3131 1 1/2" x 10		
8.163	04/96-	D0824LFL	ZF S5-42	AKB-L2018		362-019-L3131 1 1/2" x 10		
10.153	04/96 -97	D0824LFL	ZF S5-42	AKB-L2018		362-019-L3131 1 1/2" x 10		
10.163	04/96-	D0824LFL	ZF S5-42	AKB-L2018		362-019-L3131 1 1/2" x 10		
L2000 Evolution Le Cab								
8.150 LE8.150	04-	D0834LFL02	ZF S5-42	AKB-L2789	362-071-L3145	362-019-L3133 1 1/2" x 10		
8.150 LE8.150	04-	D0834LFL02	ZF S5-42	AKB-L3135	362-071-L3145	362-019-L3133 1 1/2" x 10	CB-L3417	
8.155 LE140	01-04	D0834LFL02	ZF S5-42	AKB-L2789	362-071-L3145	362-019-L3133 1 1/2" x 10		
8.155 LE140	01-04	D0834LFL02	ZF S5-42	AKB-L3135	362-071-L3145	362-019-L3133 1 1/2" x 10	CB-L3417	
8.155 LE150	01-04	D0834LFL02	ZF 16S-109 Eaton 8309	AKB-L2001		395-019-L3100 1 3/4" x 10		
8.155 LE150	01-04	D0834LFL02	ZF 6S-850	AKB-L2618	395-071-L3096	395-019-L3100 1 3/4" x 10		
8.155 LE150	01-04	D0834LFL02	ZF 6S-850	AKB-L3603	395-071-L3096	395-019-L3100 1 3/4" x 10	CB-L3417	
8.155 LE160	01-04	D0834LFL02	ZF S5-42	AKB-L2789	362-071-L3145	362-019-L3133 1 1/2" x 10		
8.155 LE160	01-04	D0834LFL02	ZF S5-42	AKB-L3135	362-071-L3145	362-019-L3133 1 1/2" x 10	CB-L3417	
8.155 LE160	01-04	D0834LFL02	ZF 16S-109 Eaton 8309	AKB-L2001		395-019-L3100 1 3/4" x 10		
8.155 LE160	01-04	D0834LFL02	ZF 6S-850	AKB-L2618	395-071-L3096	395-019-L3100 1 3/4" x 10		
8.155 LE160	01-04	D0834LFL02	ZF 6S-850	AKB-L3603	395-071-L3096	395-019-L3100 1 3/4" x 10	CB-L3417	
8.180 LE8.180	04-	D0834LFL03	ZF 6S-850	AKB-L2789	362-071-L3145	362-019-L3133 1 1/2" x 10		
8.180 LE8.180	04-	D0834LFL03	ZF 6S-850	AKB-L3135	362-071-L3145	362-019-L3133 1 1/2" x 10	CB-L3417	
8.185 LE180	01-04	D0834LFL03	ZF 16S-109 Eaton 8309	AKB-L2001		395-019-L3100 1 3/4" x 10		
8.185 LE180	01-04	D0834LFL03	ZF 6S-850	AKB-L2618	395-071-L3096	395-019-L3100 1 3/4" x 10		
8.185 LE180	01-04	D0834LFL03	ZF 6S-850	AKB-L3603	395-071-L3096	395-019-L3100 1 3/4" x 10	CB-L3417	
8.225 LE220	01-04	D0834LFL04	ZF 16S-109 Eaton 8309	AKB-L2001		395-019-L3100 1 3/4" x 10		
8.225 LE220	01-04	D0834LFL04	ZF 6S-850	AKB-L2618	395-071-L3096	395-019-L3100 1 3/4" x 10		
8.225 LE220	01-04	D0834LFL04	ZF 6S-850	AKB-L3603	395-071-L3096	395-019-L3100 1 3/4" x 10	CB-L3417	
10.180 LE10.180	04-	D0834LFL03	ZF 6S-850	AKB-L2789	362-071-L3145	362-019-L3133 1 1/2" x 10		



Vehicle

Year



Engine



Gearbox



LIPE Kit No.



LIPE cover



LIPE Disc

LIPE
Bearing

Notes

MAN Cont'd

Vehicle	Year	Engine	Gearbox	LIPE Kit No.	LIPE cover	LIPE Disc	LIPE Bearing	Notes
10.180 LE10.180	04-	D0834LFL03	ZF 6S-850	AKB-L3135	362-071-L3145	362-019-L3133 1 1/2" x 10	CB-L3417	
10.185 LE180	01-04	D0834LFL03	ZF 16S-109 Eaton 8309	AKB-L2001		395-019-L3100 1 3/4" x 10		
10.185 LE180	01-04	D0834LFL03	ZF 6S-850	AKB-L2618	395-071-L3096	395-019-L3100 1 3/4" x 10		
10.185 LE10.180	01-04	D0834LFL03	ZF 6S-850	AKB-L3603	395-071-L3096	395-019-L3100 1 3/4" x 10	CB-L3417	
10.220 LE10.220	04-	D0834LFL02	ZF 6S-850	AKB-L2789	362-071-L3145	362-019-L3133 1 1/2" x 10		
10.220 LE10.220	04-	D0834LFL02	ZF 6S-850	AKB-L3135	362-071-L3145	362-019-L3133 1 1/2" x 10	CB-L3417	
10.225 LE220	01-04	D0834LFL04	ZF 16S-109 Eaton 8309	AKB-L2001		395-019-L3100 1 3/4" x 10		
10.225 LE220	01-04	D0834LFL04	ZF 6S-850	AKB-L2618	395-071-L3096	395-019-L3100 1 3/4" x 10		
10.225 LE.220	01-04	D0834LFL04	ZF 6S-850	AKB-L3603	395-071-L3096	395-019-L3100 1 3/4" x 10	CB-L3417	
12.180 LE12.180	04-	D0834LFL03	ZF 6S-850	AKB-L2789	362-071-L3145	362-019-L3133 1 1/2" x 10		
12.180 LE12.180	04-	D0834LFL03	ZF 6S-850	AKB-L3135	362-071-L3145	362-019-L3133 1 1/2" x 10	CB-L3417	
12.185 LE180	01-04	D0834LFL03	ZF 16S-109 Eaton 8309	AKB-L2001		395-019-L3100 1 3/4" x 10		
12.185 LE180	01-04	D0834LFL03	ZF 6S-850	AKB-L2618	395-071-L3096	395-019-L3100 1 3/4" x 10		
12.220 LE12.220	04-	D0834LFL02	ZF 6S-850	AKB-L2789	362-071-L3145	362-019-L3133 1 1/2" x 10		
12.220 LE12.220	04-	D0834LFL02	ZF 6S-850	AKB-L3135	362-071-L3145	362-019-L3133 1 1/2" x 10	CB-L3417	
12.225 LE220	01-04	D0834LFL04	ZF 16S-109 Eaton 8309	AKB-L2001		395-019-L3100 1 3/4" x 10		
12.225 LE220	01-04	D0834LFL04	ZF 6S-850	AKB-L2618	395-071-L3096	395-019-L3100 1 3/4" x 10		
12.225 LE.220	01-04	D0834LFL04	ZF 6S-850	AKB-L3603	395-071-L3096	395-019-L3100 1 3/4" x 10	CB-L3417	
M2000								
12.163	04/96 -99	D0824LFL09		AKB-L2018		362-019-L3131 1 1/2" x 10		
12.163	04/96 -99	D0824LFL09		AKB-L2001		395-019-L3100 1 3/4" x 10		
12.224	96-99	D0826LFL10		AKB-L2001		395-019-L3100 1 3/4" x 10		
14.224	96-99	D0826LFL10		AKB-L2001		395-019-L3100 1 3/4" x 10		
14.264	96-99	D0826LF17 D0826LFL09		AKB-L2001		395-019-L3100 1 3/4" x 10		
14.284	99-	D0826LF01		AKB-L2001		395-019-L3100 1 3/4" x 10		
15.224	96-	D0826LF D0826LFL		AKB-L2001		395-019-L3100 1 3/4" x 10		
18.224	96-	D0826LF09 D0826LF18 D0826LFL10		AKB-L2001		395-019-L3100 1 3/4" x 10		
18.264	96-99	D0826LF17 D0826LFL09		AKB-L2001		395-019-L3100 1 3/4" x 10		
18.284	99-	D0826LF01		AKB-L2001		395-019-L3100 1 3/4" x 10		
23.264	96-99	D0826LF17		AKB-L2001		395-019-L3100 1 3/4" x 10		
23.284	99	D0826LF01		AKB-L2001		395-019-L3100 1 3/4" x 10		
26.264	96-99	D0826LF17		AKB-L2001		395-019-L3100 1 3/4" x 10		



Vehicle

Year



Engine



Gearbox



LIPE Kit No.



LIPE cover



LIPE Disc

LIPE
Bearing

Notes

MAN Cont'd

Vehicle	Year	Engine	Gearbox	LIPE Kit No.	LIPE cover	LIPE Disc	LIPE Bearing	Notes
26.284	99	D0826LF D0826LFL		AKB-L2001		395-019-L3100 1 3/4" x 10		
M2000 Evolution Le Cab								
14.220 LE14.220	04-	D0836LFL02	ZF S6-850	AKB-L2618	395-071-L3096	395-019-L3100 1 3/4" x 10		
14.220 LE14.220	04-	D0836LFL02	ZF S6-850	AKB-L3603	395-071-L3096	395-019-L3100 1 3/4" x 10	CB-L3417	
14.225 LE220	01-04	D0836LFL02	ZF S6-850	AKB-L2618	395-071-L3096	395-019-L3100 1 3/4" x 10		
14.225 LE220	01-04	D0836LFL02	ZF S6-850	AKB-L3603	395-071-L3096	395-019-L3100 1 3/4" x 10	CB-L3417	
14.280 LE14.280	04-	D0836LFL03	Eaton 8309	AKB-L2001		395-019-L3100 1 3/4" x 10		
14.285 LE280	01-04	D0836LFL03	Eaton 8309	AKB-L2001		395-019-L3100 1 3/4" x 10		
18.220 LE18.220	04-	D0836LFL02	ZF S6-850	AKB-L2618	395-071-L3096	395-019-L3100 1 3/4" x 10		
18.220 LE18.220	04-	D0836LFL02	ZF S6-850	AKB-L3603	395-071-L3096	395-019-L3100 1 3/4" x 10	CB-L3417	
18.220 LE18.220	04-	D0836LFL02	Eaton 8309	AKB-L2001		395-019-L3100 1 3/4" x 10		
18.225 LE220	01-04	D0836LFL04	Eaton 8309	AKB-L2001		395-019-L3100 1 3/4" x 10		
18.280 LE18.280	04-	D0836LFL03	Eaton 8309	AKB-L2001		395-019-L3100 1 3/4" x 10		
18.285 LE280	01-04	D0836LFL06	Eaton 8309	AKB-L2001		395-019-L3100 1 3/4" x 10		
26.280 LE26.280	04-	D0836LFL03	Eaton 8309 ZF 9S-109	AKB-L2001		395-019-L3100 1 3/4" x 10		
26.285 LE280	01-04	D0836LFL03	Eaton 8309 ZF 9S-109	AKB-L2001		395-019-L3100 1 3/4" x 10		
M2000 Evolution Me Cab								
18.220 ME18.220	04-	D0836LFL04	ZF S6-850	AKB-L3603	395-071-L3096	395-019-L3100 1 3/4" x 10	CB-L3417	
18.220 ME18.220	04-	D0836LFL04	ZF S6-850	AKB-L2618	395-071-L3096	395-019-L3100 1 3/4" x 10		
18.220 ME18.220	04-	D0836LFL04	Eaton 8309	AKB-L2001		395-019-L3100 1 3/4" x 10		
18.225 ME220	01 -09/02	D0836LFL04	ZF S6-850	AKB-L2618	395-071-L3096	395-019-L3100 1 3/4" x 10		
18.225 ME220	10/02 -04	D0836LFL04	ZF S6-850	AKB-L3603	395-071-L3096	395-019-L3100 1 3/4" x 10	CB-L3417	
18.225 ME220	01-04	D0836LFL04	Eaton 8309	AKB-L2001		395-019-L3100 1 3/4" x 10		
18.280 ME18.280	04-	D0836LFL03	ZF S6-850	AKB-L2618	395-071-L3096	395-019-L3100 1 3/4" x 10		
18.280 ME18.280	04-	D0836LFL03	ZF S6-850	AKB-L3603	395-071-L3096	395-019-L3100 1 3/4" x 10	CB-L3417	
18.280 ME18.280	04-	D0836LFL03	Eaton 8309	AKB-L2001		395-019-L3100 1 3/4" x 10		
18.285 ME280	01 -09/02	D0836LFL03	ZF S6-850	AKB-L2618	395-071-L3096	395-019-L3100 1 3/4" x 10		
18.285 ME280	10/02 -04	D0836LFL03	ZF S6-850	AKB-L3603	395-071-L3096	395-019-L3100 1 3/4" x 10	CB-L3417	
18.285 ME280	01-04	D0836LFL03	Eaton 8309	AKB-L2001		395-019-L3100 1 3/4" x 10		
25.280 ME25.280	04-	D0836LFL03	Eaton 8309	AKB-L2001		395-019-L3100 1 3/4" x 10		
25.285 ME280	01-04	D0836LFL03	Eaton 8309	AKB-L2001		395-019-L3100 1 3/4" x 10		



Vehicle

Year



Engine



Gearbox



LIPE Kit No.



LIPE cover



LIPE Disc







LIPE
Bearing









Notes







MAN Cont'd

TG-A

Vehicle	Year	Engine	Gearbox	LIPE Kit No.	LIPE cover	LIPE Disc	LIPE Bearing	Notes
18.313TGA18.310	01-04	D2866LF26	ZF 16S-151	AKB-L2627	430-701-L2320	430-019-L2321 2" x 10	CB-L1961	
18.313TGA18.310	01-04	D2866LF26	A STronic	AKB-L2011	430-701-L2320	430-019-L2321 2" x 10	CB-L1339	
18.313TGA18.310	01-04	D2866LF26	A STronic	AKB-L3609	430-701-L2320	430-019-L2321 2" x 10	CB-L3490	
18.320	05/04-	D2066	ZF	AKB-L2456	430-701-L2320	430-019-L2321 2" x 10	CB-L1961	
18.320	05/04-	D2066	A STronic	AKB-L2011	430-701-L2320	430-019-L2321 2" x 10	CB-L1339	
18.363TGA18.360	99-04	D2866LF27	ZF 16S-181	AKB-L2627	430-701-L2320	430-019-L2321 2" x 10	CB-L1961	
18.363TGA18.360	99-04	D2866LF27	A STronic	AKB-L2011	430-701-L2320	430-019-L2321 2" x 10	CB-L1339	
18.363TGA18.360	99-04	D2866LF27	A STronic	AKB-L3609	430-701-L2320	430-019-L2321 2" x 10	CB-L3490	
18.360	05/04-	D2066	ZF	AKB-L2456	430-701-L2320	430-019-L2321 2" x 10	CB-L1961	
18.360	05/04-	D2066	A STronic	AKB-L2011	430-701-L2320	430-019-L2321 2" x 10	CB-L1339	
18.400	05/04-	D2066	ZF	AKB-L2456	430-701-L2320	430-019-L2321 2" x 10	CB-L1961	
18.400	05/04-	D2066	A STronic	AKB-L2011	430-701-L2320	430-019-L2321 2" x 10	CB-L1339	
18.413TGA18.410	01-04	D2866LF28	ZF 16S-181	AKB-L2627	430-701-L2320	430-019-L2321 2" x 10	CB-L1961	
18.413TGA18.410	01-04	D2866LF28	A STronic	AKB-L2011	430-701-L2320	430-019-L2321 2" x 10	CB-L1339	
18.363TGA18.360	01-04	D2866LF28	A STronic	AKB-L3609	430-701-L2320	430-019-L2321 2" x 10	CB-L3490	
18.440	05/04-	D2066	ZF	AKB-L3611	430-701-L3610	430-019-L3611 2" x 10	CB-L1961	
18.440	05/04-	D2066	A STronic	AKB-L3613	430-701-L3610	430-019-L3611 2" x 10	CB-L1339	
18.440	05/04-	D2066	A STronic	AKB-L3614	430-701-L3610	430-019-L3611 2" x 10	CB-L3490	
18.463TGA18.460	01-04	D2876LF04	ZF 16S-181	AKB-L3611	430-701-L3610	430-019-L3611 2" x 10	CB-L1961	
18.463TGA18.460	01-04	D2876LF04	A STronic	AKB-L3613	430-701-L3610	430-019-L3611 2" x 10	CB-L1339	
18.463TGA18.460				AKB-L3614	430-701-L3610	430-019-L3611 2" x 10	CB-L3490	
14.483TGA 18.480	09/02-	D2876F12	ZF 16S	AKB-L3611	430-701-L3610	430-019-L3611 2" x 10	CB-L1961	
14.483TGA 18.480	09/02-	D2876F12	A STronic	AKB-L3613	430-701-L3610	430-019-L3611 2" x 10	CB-L1339	
14.483TGA 18.480	09/02-	D2876F12	A STronic	AKB-L3614	430-701-L3610	430-019-L3611 2" x 10	CB-L3490	
14.480	05/06	D2876	ZF	AKB-L3611	430-701-L3610	430-019-L3611 2" x 10	CB-L1961	
14.480	05/06	D2876	A STronic	AKB-L3613	430-701-L3610	430-019-L3611 2" x 10	CB-L1339	
14.480	05/06	D2876	A STronic	AKB-L3614	430-701-L3610	430-019-L3611 2" x 10	CB-L3490	
18.513TGA18.510	01-04	D2876LF05	ZF 16S-221	AKB-L3611	430-701-L3610	430-019-L3611 2" x 10	CB-L1961	
18.513TGA18.510	01-04	D2876LF05	A STronic	AKB-L3613	430-701-L3610	430-019-L3611 2" x 10	CB-L1339	
18.513TGA18.510	01-04	D2876LF05	A STronic	AKB-L3614	430-701-L3610	430-019-L3611 2" x 10	CB-L3490	
18.533TGA18.530	02-04	D2876LF13	ZF	AKB-L3611	430-701-L3610	430-019-L3611 2" x 10	CB-L1961	
18.533TGA18.530	02-04	D2876LF13	A STronic	AKB-L3613	430-701-L3610	430-019-L3611 2" x 10	CB-L1339	

 Vehicle	Year	 Engine	 Gearbox	 LIPE Kit No.	 LIPE cover	 LIPE Disc	 LIPE Bearing	Notes
MAN Cont'd								
18.533TGA18.530	02-04	D2876LF13	A STronic	AKB-L3614	430-701-L3610	430-019-L3611 2" x 10	CB-L3490	
24.360	05/04-	D2066	ZF	AKB-L2456	430-701-L2320	430-019-L2321 2" x 10	CB-L1961	
24.360	05/04-	D2066	A STronic	AKB-L3611	430-701-L3610	430-019-L3611 2" x 10	CB-L1961	
24.400	05/04-	D2066	ZF	AKB-L2456	430-701-L2320	430-019-L2321 2" x 10	CB-L1961	
24.400	05/04-	D2066	A STronic	AKB-L3611	430-701-L3610	430-019-L3611 2" x 10	CB-L1961	
24.440	05/04-	D2066	ZF	AKB-L3611	430-701-L3610	430-019-L3611 2" x 10	CB-L1961	
24.440	05/04-	D2066	A STronic	AKB-L3613	430-701-L3610	430-019-L3611 2" x 10	CB-L1339	
24.440	05/04-	D2066	A STronic	AKB-L3614	430-701-L3610	430-019-L3611 2" x 10	CB-L3490	
26.313TGA26.310	01-	D2866LF26	ZF 16S	AKB-L2627	430-701-L2320	430-019-L2321 2" x 10	CB-L1961	
26.313TGA26.310	01-	D2866LF26	A STronic	AKB-L2011	430-701-L2320	430-019-L2321 2" x 10	CB-L1339	
26.313TGA26.310	01-	D2866LF26	A STronic	AKB-L3609	430-701-L2320	430-019-L2321 2" x 10	CB-L3490	
26.320	05/04-	D2066	ZF	AKB-L2456	430-701-L2320	430-019-L2321 2" x 10	CB-L1961	
26.320	05/04-	D2066	A STronic	AKB-L3611	430-701-L3610	430-019-L3611 2" x 10	CB-L1961	
26.363TGA26.360	99-04	D2866LF27	ZF 16S-181	AKB-L2627	430-701-L2320	430-019-L2321 2" x 10	CB-L1961	
26.363TGA26.360	99-04	D2866LF27	A STronic	AKB-L2011	430-701-L2320	430-019-L2321 2" x 10	CB-L1339	
26.363TGA26.360	99-04	D2866LF27	A STronic	AKB-L3609	430-701-L2320	430-019-L2321 2" x 10	CB-L3490	
26.360	05/04-	D2066	ZF	AKB-L2456	430-701-L2320	430-019-L2321 2" x 10	CB-L1961	
26.360	05/04-	D2066	A STronic	AKB-L3611	430-701-L3610	430-019-L3611 2" x 10	CB-L1961	
26.400	05/04-	D2066	ZF	AKB-L2456	430-701-L2320	430-019-L2321 2" x 10	CB-L1961	
26.400	05/04-	D2066	A STronic	AKB-L3611	430-701-L3610	430-019-L3611 2" x 10	CB-L1961	
26.413TGA26.410	01-04	D2866LF28	ZF 16S-181	AKB-L2627	430-701-L2320	430-019-L2321 2" x 10	CB-L1961	
26.413TGA26.410	01-04	D2866LF28	A STronic	AKB-L2011	430-701-L2320	430-019-L2321 2" x 10	CB-L1339	
26.413TGA26.410	01-04	D2866LF28	A STronic	AKB-L3609	430-701-L2320	430-019-L2321 2" x 10	CB-L3490	
26.430	02/04-	D2066	ZF	AKB-L3611	430-701-L3610	430-019-L3611 2" x 10	CB-L1961	
26.430	02/04-	D2066	A STronic	AKB-L3613	430-701-L3610	430-019-L3611 2" x 10	CB-L1339	
26.430	02/04-	D2066	A STronic	AKB-L3614	430-701-L3610	430-019-L3611 2" x 10	CB-L3490	
26.440	02/04-	D2066	ZF	AKB-L3611	430-701-L3610	430-019-L3611 2" x 10	CB-L1961	
26.440	02/04-	D2066	A STronic	AKB-L3613	430-701-L3610	430-019-L3611 2" x 10	CB-L1339	
26.440	02/04-	D2066	A STronic	AKB-L3614	430-701-L3610	430-019-L3611 2" x 10	CB-L3490	
26.463TGA26.460	01-04	D2876LF04	ZF 16S-181	AKB-L3611	430-701-L3610	430-019-L3611 2" x 10	CB-L1961	
26.463TGA26.460	01-04	D2876LF04	A STronic	AKB-L3613	430-701-L3610	430-019-L3611 2" x 10	CB-L1339	
26.463TGA26.460	01-04	D2876LF04	A STronic	AKB-L3614	430-701-L3610	430-019-L3611 2" x 10	CB-L3490	
26.480	02/06-	D2676	ZF	AKB-L3611	430-701-L3610	430-019-L3611 2" x 10	CB-L1961	

 Vehicle	 Year	 Engine	 Gearbox	 LIPE Kit No.	 LIPE cover	 LIPE Disc	 LIPE Bearing	Notes
MAN Cont'd								
26.480	02/06-	D2676	A STronic	AKB-L3613	430-701-L3610	430-019-L3611 2" x 10	CB-L1339	
26.480	02/06-	D2676	A STronic	AKB-L3614	430-701-L3610	430-019-L3611 2" x 10	CB-L3490	
26.513TGA26.510	01-04	D2876LF05	ZF 16S-221	AKB-L3611	430-701-L3610	430-019-L3611 2" x 10	CB-L1961	
26.513TGA26.510	01-04	D2876LF05	A STronic	AKB-L3613	430-701-L3610	430-019-L3611 2" x 10	CB-L1339	
26.513TGA26.510	01-04	D2876LF05	A STronic	AKB-L3614	430-701-L3610	430-019-L3611 2" x 10	CB-L3490	
26.533TGA26.530	02-04	D2876LF13	ZF	AKB-L3611	430-701-L3610	430-019-L3611 2" x 10	CB-L1961	
26.533TGA26.530	02-04	D2876LF13	A STronic	AKB-L3613	430-701-L3610	430-019-L3611 2" x 10	CB-L1339	
26.533TGA26.530	02-04	D2876LF13	A STronic	AKB-L3614	430-701-L3610	430-019-L3611 2" x 10	CB-L3490	
32.360	02-04	D2066	ZF	AKB-L2456	430-701-L2320	430-019-L2321 2" x 10	CB-L1961	
32.360	02-04	D2066	A STronic	AKB-L3611	430-701-L3610	430-019-L3611 2" x 10	CB-L1961	
32.400	02-04	D2066	ZF	AKB-L2456	430-701-L2320	430-019-L2321 2" x 10	CB-L1961	
32.400	02-04	D2066	A STronic	AKB-L3611	430-701-L3610	430-019-L3611 2" x 10	CB-L1961	
32.440	02-04	D2066	ZF	AKB-L3611	430-701-L3610	430-019-L3611 2" x 10	CB-L1961	
32.440	02-04	D2066	A STronic	AKB-L3613	430-701-L3610	430-019-L3611 2" x 10	CB-L1339	
32.440	02-04	D2066	A STronic	AKB-L3614	430-701-L3610	430-019-L3611 2" x 10	CB-L3490	
33.463TGA33.460	01-04	D2876LF04	ZF 16S-181	AKB-L3611	430-701-L3610	430-019-L3611 2" x 10	CB-L1961	
33.463TGA33.460	01-04	D2876LF04	A STronic	AKB-L3613	430-701-L3610	430-019-L3611 2" x 10	CB-L1339	
33.463TGA33.460	01-04	D2876LF04	A STronic	AKB-L3614	430-701-L3610	430-019-L3611 2" x 10	CB-L3490	
35.360	05/04-	D2066	ZF	AKB-L2456	430-701-L2320	430-019-L2321 2" x 10	CB-L1961	
35.360	05/04-	D2066	A STronic	AKB-L3611	430-701-L3610	430-019-L3611 2" x 10	CB-L1961	
35.400	05/04-	D2066	ZF	AKB-L2456	430-701-L2320	430-019-L2321 2" x 10	CB-L1961	
35.400	05/04-	D2066	A STronic	AKB-L3611	430-701-L3610	430-019-L3611 2" x 10	CB-L1961	
32.440	05/04-	D2066	ZF	AKB-L3611	430-701-L3610	430-019-L3611 2" x 10	CB-L1961	
32.440	05/04-	D2066	A STronic	AKB-L3613	430-701-L3610	430-019-L3611 2" x 10	CB-L1339	
32.440	05/04-	D2066	A STronic	AKB-L3614	430-701-L3610	430-019-L3611 2" x 10	CB-L3490	
TG-L								
7.150	05-	D0834LFL40 D0834LFL50	ZF S5-42 ZF 6S850	AKB-L2789	362-071-L3145	362-019-L3133 1 1/2" x 10		
7.150	05-	D0834LFL40 D0834LFL50	ZF 6AS850	AKB-L2789	362-071-L3145	362-019-L3133 1 1/2" x 10		
7.180	05-	D0834LFL41 D0834LFL51	ZF S5-42 ZF 6S850	AKB-L2789	362-071-L3145	362-019-L3133 1 1/2" x 10		
7.180	05-	D0834LFL41 D0834LFL51	ZF 6AS850	AKB-L2789	362-071-L3145	362-019-L3133 1 1/2" x 10		
8.150	05-	D0834LFL40 D0834LFL50	ZF S5-42 ZF 6S850	AKB-L2789	362-071-L3145	362-019-L3133 1 1/2" x 10		
8.150	05-	D0834LFL40 D0834LFL50	ZF 6AS850	AKB-L2789	362-071-L3145	362-019-L3133 1 1/2" x 10		
8.180	05-	D0834LFL41 D0834LFL51	ZF S5-42 ZF 6S850	AKB-L2789	362-071-L3145	362-019-L3133 1 1/2" x 10		







 Vehicle	Year	 Engine	 Gearbox	 LIPE Kit No.	 LIPE cover	 LIPE Disc	 LIPE Bearing	Notes
MAN Cont'd								
8.180	05-	D0834LFL41 D0834LFL51	ZF 6AS850	AKB-L2789	362-071-L3145	362-019-L3133 1 1/2" x 10		
8.210	05-	D0834LFL42 D0834LFL52	ZF S5-42 ZF 6S850	AKB-L2789	362-071-L3145	362-019-L3133 1 1/2" x 10		
8.210	05-	D0834LFL42 D0834LFL52	ZF 6AS850	AKB-L2789	362-071-L3145	362-019-L3133 1 1/2" x 10		
8.240	05-	D0836LFL40 D0836LFL50	Eaton FS-8309 FSO-8309	AKB-L2001		395-019-L3100 1 3/4" x 10		
10.180	05-	D0834LFL41 D0834LFL51	ZF S5-42 ZF 6S850	AKB-L2789	362-071-L3145	362-019-L3133 1 1/2" x 10		
10.180	05-	D0834LFL41 D0834LFL51	ZF 6AS850	AKB-L2789	362-071-L3145	362-019-L3133 1 1/2" x 10		
10.210	05-	D0834LFL42 D0834LFL52	ZF S5-42 ZF 6S850	AKB-L2789	362-071-L3145	362-019-L3133 1 1/2" x 10		
10.210	05-	D0834LFL42 D0834LFL52	ZF 6AS850	AKB-L2789	362-071-L3145	362-019-L3133 1 1/2" x 10		
10.240	05-	D0836LFL40 D0836LFL50	Eaton FS-8309 FSO-8309	AKB-L2001		395-019-L3100 1 3/4" x 10		
12.180	05-	D0834LFL41 D0834LFL51	ZF S5-42 ZF 6S850	AKB-L2789	362-071-L3145	362-019-L3133 1 1/2" x 10		
12.180	05-	D0834LFL41 D0834LFL51	ZF 6AS850	AKB-L2789	362-071-L3145	362-019-L3133 1 1/2" x 10		
12.210	05-	D0834LFL42 D0834LFL52	ZF S5-42 ZF 6S850	AKB-L2789	362-071-L3145	362-019-L3133 1 1/2" x 10		
12.210	05-	D0834LFL42 D0834LFL52	ZF 6AS850	AKB-L2789	362-071-L3145	362-019-L3133 1 1/2" x 10		
12.240	05-	D0836LFL40 D0836LFL50	Eaton FS-8309 FSO-8309	AKB-L2001		395-019-L3100 1 3/4" x 10		







TG-M

18.280	05-	D0834LFL41 D0834LFL51	12AS1210 TO A STronic	AKB-L2618	395-071-L3096	395-019-L3100 1 3/4" x 10		
--------	-----	--------------------------	--------------------------	-----------	---------------	------------------------------	--	--







MERCEDES BENZ**Actros**



1831	10/96-03	OM501LA	G211-16	AKB-L2205	430-701-L3086	430-019-L1775 18 x 50	CB-L1781	
1831	10/96-03	OM501LA	G211-16	AKB-L2084	400-702-L3504	400-019-L3506 400-019-L3505 18 x 50	CB-L2692	
1831 L, LS	10/96-03	OM501LA	G211-16	AKB-L2204	430-701-L3086	430-019-L1775 18 x 50	CB-L1781	
1831 L, LS	10/96-03	OM501LA	G211-16	AKB-L2204	430-701-L3086	430-019-L1775 18 x 50	CB-L1781	
1835	10/96-03	OM501LA	G211-16	AKB-L2205	430-701-L3086	430-019-L1775 18 x 50	CB-L1781	
1835	10/96-03	OM501LA	G211-16	AKB-L2084	400-702-L3504	400-019-L3506 400-019-L3505 18 x 50	CB-L2692	
1835 L, LS	10/96-03	OM501LA	G211-16	AKB-L2204	430-701-L3086	430-019-L1775 18 x 50	CB-L1781	
1835 L, LS	10/96-03	OM501LA	G211-16	AKB-L2204	430-701-L3086	430-019-L1775 18 x 50	CB-L1781	
1836	03-	OM501LA	G211-16	AKB-L2204	430-701-L3086	430-019-L1775 18 x 50	CB-L1781	
1836	03-	OM501LA	G211-16	AKB-L2204	430-701-L3086	430-019-L1775 18 x 50	CB-L1781	
1836	03-	OM501LA	G211-16	AKB-L2084	400-702-L3504	400-019-L3506 400-019-L3505 18 x 50	CB-L2692	
1836	03-	OM501LA	G211-16	AKB-L2204	430-701-L3086	430-019-L1775 18 x 50	CB-L1781	
1840	97-	OM501LA	G211-16	AKB-L2204	430-701-L3086	430-019-L1775 18 x 50	CB-L1781	







 Vehicle	Year	 Engine	 Gearbox	 LIPE Kit No.	 LIPE cover	 LIPE Disc	 LIPE Bearing	Notes
MERCEDES BENZ Cont'd								
1840	97-	OM501LA	G211-16	AKB-L2084	400-702-L3504	400-019-L3506 400-019-L3505 18 x 50	CB-L2692	
1841	03-	OM501LA	G211-16	AKB-L2204	430-701-L3086	430-019-L1775 18 x 50	CB-L1781	
1841	03-	OM501LA	G211-16	AKB-L2204	430-701-L3086	430-019-L1775 18 x 50	CB-L1781	
1841	03-	OM501LA	G211-16	AKB-L2084	400-702-L3504	400-019-L3506 400-019-L3505 18 x 50	CB-L2692	
1841	03-	OM501LA	G211-16	AKB-L2204	430-701-L3086	430-019-L1775 18 x 50	CB-L1781	
1843	97-	OM501LA	G211-16	AKB-L2204	430-701-L3086	430-019-L1775 18 x 50	CB-L1781	
1843	97-	OM501LA	G211-16	AKB-L2084	400-702-L3504	400-019-L3506 400-019-L3505 18 x 50	CB-L2692	
1844	03-	OM501LA	G211-16 G240-16	AKB-L2204	430-701-L3086	430-019-L1775 18 x 50	CB-L1781	
1844	03-	OM501LA	G211-16 G240-16	AKB-L2204	430-701-L3086	430-019-L1775 18 x 50	CB-L1781	
1844	03-	OM501LA	G211-16 G240-16	AKB-L2084	400-702-L3504	400-019-L3506 400-019-L3505 18 x 50	CB-L2692	
1844	03-	OM501LA	G211-16 G240-16	AKB-L2204	430-701-L3086	430-019-L1775 18 x 50	CB-L1781	
1844	03-	OM501LA	G240-16	AKB-L3615	430-701-L3086	430-019-L1775 18 x 50	CB-L2693	
1844	03-	OM501LA	G240-16	AKB-L2084	400-702-L3504	400-019-L3506 400-019-L3505 18 x 50	CB-L2692	
1844	03-	OM501LA	G240-16	AKB-L2084	400-702-L3504	400-019-L3506 400-019-L3505 18 x 50	CB-L2692	
1846	03-	OM501LA	G230-16 G231-16 G240-16	AKB-L2204	430-701-L3086	430-019-L1775 18 x 50	CB-L1781	
1846	03-	OM501LA	G230-16 G231-16 G240-16	AKB-L2204	430-701-L3086	430-019-L1775 18 x 50	CB-L1781	
1846	03-	OM501LA	G230-16 G231-16 G240-16	AKB-L2084	400-702-L3504	400-019-L3506 400-019-L3505 18 x 50	CB-L2692	
1846	03-	OM501LA	G230-16 G231-16 G240-16	AKB-L2204	430-701-L3086	430-019-L1775 18 x 50	CB-L1781	
1846 LS	03-	OM501LA	G230-16 G231-16 G240-16	AKB-L2204	430-701-L3086	430-019-L1775 18 x 50	CB-L1781	
1846 LS	03-	OM501LA	G230-16 G231-16 G240-16	AKB-L2084	400-702-L3504	400-019-L3506 400-019-L3505 18 x 50	CB-L2692	
1846 LS	03-	OM501LA	G230-16 G231-16 G240-16	AKB-L3615	430-701-L3086	430-019-L1775 18 x 50	CB-L2693	
1846 LS	03-	OM501LA	G230-16 G231-16 G240-16	AKB-L2084	400-702-L3504	400-019-L3506 400-019-L3505 18 x 50	CB-L2692	
1846 LS	03-	OM501LA	G230-16 G231-16 G240-16	AKB-L2084	400-702-L3504	400-019-L3506 400-019-L3505 18 x 50	CB-L2692	
1848	97-	OM502LA		AKB-L2084	400-702-L3504	400-019-L3506 400-019-L3505 18 x 50	CB-L2692	
1848 L	03-	OM502LA	G231-16	AKB-L2204	430-701-L3086	430-019-L1775 18 x 50	CB-L1781	
1848 L	03-	OM502LA	G240-16	AKB-L2204	430-701-L3086	430-019-L1775 18 x 50	CB-L1781	

 Vehicle	Year	 Engine	 Gearbox	 LIPE Kit No.	 LIPE cover	 LIPE Disc	 LIPE Bearing	Notes
MERCEDES BENZ Cont'd								
1848 L	03-	OM502LA	G240-16	AKB-L2204	430-701-L3086	430-019-L1775 18 x 50	CB-L1781	
1848 L	03-	OM502LA	G240-16	AKB-L2084	400-702-L3504	400-019-L3506 400-019-L3505 18 x 50	CB-L2692	
1848 LS	03-	OM502LA	G211-16	AKB-L2204	430-701-L3086	430-019-L1775 18 x 50	CB-L1781	
1848 LS	03-	OM502LA	G211-16	AKB-L2084	400-702-L3504	400-019-L3506 400-019-L3505 18 x 50	CB-L2692	
1848 LS	03-	OM502LA	G211-16	AKB-L2204	430-701-L3086	430-019-L1775 18 x 50	CB-L1781	
1848 AK,K,LS	03-	OM502LA	G211-16	AKB-L2204	430-701-L3086	430-019-L1775 18 x 50	CB-L1781	
1848 AK,K,LS	03-	OM502LA	G211-16	AKB-L2084	400-702-L3504	400-019-L3506 400-019-L3505 18 x 50	CB-L2692	
1848 AK,K,LS	03-	OM502LA	G211-16	AKB-L3615	430-701-L3086	430-019-L1775 18 x 50	CB-L2693	
1848 AK,K,LS	03-	OM502LA	G211-16	AKB-L2084	400-702-L3504	400-019-L3506 400-019-L3505 18 x 50	CB-L2692	
1848 AK,K,LS	03-	OM502LA	G211-16	AKB-L2084	400-702-L3504	400-019-L3506 400-019-L3505 18 x 50	CB-L2692	
1850	03-	OM502LA	G240-16	AKB-L2204	430-701-L3086	430-019-L1775 18 x 50	CB-L1781	
1850 LS	03-	OM502LA	G240-16	AKB-L2204	430-701-L3086	430-019-L1775 18 x 50	CB-L1781	
1850	03-	OM502LA	G240-16	AKB-L2084	400-702-L3504	400-019-L3506 400-019-L3505 18 x 50	CB-L2692	
1850	03-	OM502LA	G240-16	AKB-L2204	430-701-L3086	430-019-L1775 18 x 50	CB-L1781	
1850 Equip. LS	03-	OM502LA	G240-16	AKB-L2084	400-702-L3504	400-019-L3506 400-019-L3505 18 x 50	CB-L2692	
1850 LS	03-	OM502LA	G240-16	AKB-L2084	400-702-L3504	400-019-L3506 400-019-L3505 18 x 50	CB-L2692	
1850 LS	03-	OM502LA	G240-16	AKB-L2084	400-702-L3504	400-019-L3506 400-019-L3505 18 x 50	CB-L2692	
1851 LS	03-	OM502LA	G240-16 G241-16	AKB-L2204	430-701-L3086	430-019-L1775 18 x 50	CB-L1781	
1851 LS	03-	OM502LA	G240-16 G241-16	AKB-L2084	400-702-L3504	400-019-L3506 400-019-L3505 18 x 50	CB-L2692	
1851 LS	03-	OM502LA	G240-16 G241-16	AKB-L2084	400-702-L3504	400-019-L3506 400-019-L3505 18 x 50	CB-L2692	
1851 LS	03-	OM502LA	G240-16 G241-16	AKB-L2084	400-702-L3504	400-019-L3506 400-019-L3505 18 x 50	CB-L2692	
1853	97-	OM502LA		AKB-L2084	400-702-L3504	400-019-L3506 400-019-L3505 18 x 50	CB-L2692	
1853 LS	10/96-03	OM502LA	G240-16	AKB-L2204	430-701-L3086	430-019-L1775 18 x 50	CB-L1781	
1853 LS	10/96-03	OM502LA	G240-16	AKB-L2084	400-702-L3504	400-019-L3506 400-019-L3505 18 x 50	CB-L2692	
1853 LS	10/96-03	OM502LA	G240-16	AKB-L2204	430-701-L3086	430-019-L1775 18 x 50	CB-L1781	
1854	03-	OM502LA	G240-16	AKB-L2204	430-701-L3086	430-019-L1775 18 x 50	CB-L1781	
1854	03-	OM502LA	G240-16	AKB-L2084	400-702-L3504	400-019-L3506 400-019-L3505 18 x 50	CB-L2692	





 Vehicle	 Year	 Engine	 Gearbox	 LIPE Kit No.	 LIPE cover	 LIPE Disc	 LIPE Bearing	Notes
MERCEDES BENZ Cont'd								
1854	03-	OM502LA	G240-16	AKB-L2204	430-701-L3086	430-019-L1775 18 x 50	CB-L1781	
1854 LS	03-	OM502LA	G240-16	AKB-L2084	400-702-L3504	400-019-L3506 400-019-L3505 18 x 50	CB-L2692	
1854 LS	03-	OM502LA	G240-16	AKB-L2084	400-702-L3504	400-019-L3506 400-019-L3505 18 x 50	CB-L2692	
1854 LS	03-	OM502LA	G240-16	AKB-L2084	400-702-L3504	400-019-L3506 400-019-L3505 18 x 50	CB-L2692	
1857	97-	OM502LA		AKB-L2084	400-702-L3504	400-019-L3506 400-019-L3505 18 x 50	CB-L2692	
1858	03-	OM502LA	G260-16	AKB-L2204	430-701-L3086	430-019-L1775 18 x 50	CB-L1781	
1858	03-	OM502LA	G260-16	AKB-L2204	430-701-L3086	430-019-L1775 18 x 50	CB-L1781	
1858	03-	OM502LA	G260-16	AKB-L2084	400-702-L3504	400-019-L3506 400-019-L3505 18 x 50	CB-L2692	
1858	03-	OM502LA	G260-16	AKB-L2204	430-701-L3086	430-019-L1775 18 x 50	CB-L1781	
1858 LS	03-	OM502LA	G240-16	AKB-L2204	430-701-L3086	430-019-L1775 18 x 50	CB-L1781	
1858LS	03-	OM502LA	G240-16	AKB-L2084	400-702-L3504	400-019-L3506 400-019-L3505 18 x 50	CB-L2692	
1858 LS	03-	OM502LA	G240-16	AKB-L2084	400-702-L3504	400-019-L3506 400-019-L3505 18 x 50	CB-L2692	
2531	98-	OM501LA	G240-16	AKB-L2205	430-701-L3086	430-019-L1775 18 x 50	CB-L1781	
2531	02/98-03	OM501LA	G240-16	AKB-L2204	430-701-L3086	430-019-L1775 18 x 50	CB-L1781	
2531	02/98-03	OM502LA	G240-16	AKB-L2204	430-701-L3086	430-019-L1775 18 x 50	CB-L1781	
2535	97-	OM501LA		AKB-L2205	430-701-L3086	430-019-L1775 18 x 50	CB-L1781	
2535	02/98-03	OM501LA	G240-16	AKB-L2204	430-701-L3086	430-019-L1775 18 x 50	CB-L1781	
2535	02/98-03	OM502LA	G240-16	AKB-L2204	430-701-L3086	430-019-L1775 18 x 50	CB-L1781	
2536	03-	OM501LA	G211-16	AKB-L2204	430-701-L3086	430-019-L1775 18 x 50	CB-L1781	
2536	03-	OM501LA	G211-16	AKB-L2084	400-702-L3504	400-019-L3506 400-019-L3505 18 x 50	CB-L2692	
2536	03-	OM501LA	G211-16	AKB-L2204	430-701-L3086	430-019-L1775 18 x 50	CB-L1781	
2536	03-	OM502LA	G211-16	AKB-L2204	430-701-L3086	430-019-L1775 18 x 50	CB-L1781	
2536	03-	OM501LA	G211-16	AKB-L2084	400-702-L3504	400-019-L3506 400-019-L3505 18 x 50	CB-L2692	
2540	10/96-03	OM501LA		AKB-L2204	430-701-L3086	430-019-L1775 18 x 50	CB-L1781	
2540	10/96-03	OM502LA		AKB-L2204	430-701-L3086	430-019-L1775 18 x 50	CB-L1781	
2541	03-	OM501LA	G211-16	AKB-L2205	430-701-L3086	430-019-L1775 18 x 50	CB-L1781	
2541	03-	OM501LA	G211-16	AKB-L2204	430-701-L3086	430-019-L1775 18 x 50	CB-L1781	
2541	03-	OM501LA	G211-16	AKB-L2204	430-701-L3086	430-019-L1775 18 x 50	CB-L1781	
2541	03-	OM501LA	G211-16	AKB-L2084	400-702-L3504	400-019-L3506 400-019-L3505 18 x 50	CB-L2692	





 Vehicle	Year	 Engine	 Gearbox	 LIPE Kit No.	 LIPE cover	 LIPE Disc	 LIPE Bearing	Notes
MERCEDES BENZ Cont'd								
2543	10/96-03	OM501LA	G240-16	AKB-L2084	400-702-L3504	400-019-L3506 400-019-L3505 18 x 50	CB-L2692	
2543	10/96-03		G240-16	AKB-L2204	430-701-L3086	430-019-L1775 18 x 50	CB-L1781	
2544	03-	OM501LA	G211-16	AKB-L2204	430-701-L3086	430-019-L1775 18 x 50	CB-L1781	
2544	03-	OM501LA	G211-16	AKB-L2204	430-701-L3086	430-019-L1775 18 x 50	CB-L1781	
2544	03-	OM501LA	G211-16	AKB-L2084	400-702-L3504	400-019-L3506 400-019-L3505 18 x 50	CB-L2692	
2544	03-	OM501LA	G211-16	AKB-L2204	430-701-L3086	430-019-L1775 18 x 50	CB-L1781	
2544	03-	OM501LA	G211-16	AKB-L2084	400-702-L3504	400-019-L3506 400-019-L3505 18 x 50	CB-L2692	
2544 LS	03-	OM501LA	G211-16	AKB-L2204	430-701-L3086	430-019-L1775 18 x 50	CB-L1781	
2544 LS	03-	OM501LA	G211-16	AKB-L2084	400-702-L3504	400-019-L3506 400-019-L3505 18 x 50	CB-L2692	
2544 LS	03-	OM501LA	G211-16	AKB-L3615	430-701-L3086	430-019-L1775 18 x 50	CB-L2693	
2544 LS	03-	OM501LA	G211-16	AKB-L2084	400-702-L3504	400-019-L3506 400-019-L3505 18 x 50	CB-L2692	
2546	03-	OM501LA	G231-16	AKB-L2204	430-701-L3086	430-019-L1775 18 x 50	CB-L1781	
2546	03-	OM501LA	G231-16	AKB-L2204	430-701-L3086	430-019-L1775 18 x 50	CB-L1781	
2546	03-	OM501LA	G231-16	AKB-L2204	430-701-L3086	430-019-L1775 18 x 50	CB-L1781	
2546	03-	OM501LA	G231-16	AKB-L2084	400-702-L3504	400-019-L3506 400-019-L3505 18 x 50	CB-L2692	
2546 LS	03-	OM501LA	G211-16	AKB-L2204	430-701-L3086	430-019-L1775 18 x 50	CB-L1781	
2546 LS	03-	OM501LA	G211-16	AKB-L2084	400-702-L3504	400-019-L3506 400-019-L3505 18 x 50	CB-L2692	
2546 LS	03-	OM501LA	G211-16	AKB-L3615	430-701-L3086	430-019-L1775 18 x 50	CB-L2693	
2546 LS	03-	OM501LA	G211-16	AKB-L2084	400-702-L3504	400-019-L3506 400-019-L3505 18 x 50	CB-L2692	
2548	97-	OM502LA		AKB-L2084	400-702-L3504	400-019-L3506 400-019-L3505 18 x 50	CB-L2692	
2548 L,LS	10/96-03	OM501LA	G240-16	AKB-L2204	430-701-L3086	430-019-L1775 18 x 50	CB-L1781	
2548 L,LS	10/96-03	OM502LA	G240-16	AKB-L2084	400-702-L3504	400-019-L3506 400-019-L3505 18 x 50	CB-L2692	
2548 L,LS	10/96-03	OM502LA	G240-16	AKB-L2204	430-701-L3086	430-019-L1775 18 x 50	CB-L1781	
2548 L	03 -	OM502LA	G231-16	AKB-L2204	430-701-L3086	430-019-L1775 18 x 50	CB-L1781	
2548 L	03 -	OM502LA	G231-16	AKB-L2204	430-701-L3086	430-019-L1775 18 x 50	CB-L1781	
2548 L	03 -	OM502LA	G231-16	AKB-L2204	430-701-L3086	430-019-L1775 18 x 50	CB-L1781	
2548 L	03 -	OM502LA	G231-16	AKB-L2084	400-702-L3504	400-019-L3506 400-019-L3505 18 x 50	CB-L2692	
2548 LS	03 -	OM501LA OM502LA	G240-16 G280-16	AKB-L2204	430-701-L3086	430-019-L1775 18 x 50	CB-L1781	

 Vehicle	Year	 Engine	 Gearbox	 LIPE Kit No.	 LIPE cover	 LIPE Disc	 LIPE Bearing	Notes
MERCEDES BENZ Cont'd								
2548 LS	03 -	OM501LA OM502LA	G240-16 G280-16	AKB-L2084	400-702-L3504	400-019-L3506 400-019-L3505 18 x 50	CB-L2692	
2548 LS	03 -	OM501LA OM502LA	G240-16 G280-16	AKB-L3615	430-701-L3086	430-019-L1775 18 x 50	CB-L2693	
2548 LS	03 -	OM501LA OM502LA	G240-16 G280-16	AKB-L2084	400-702-L3504	400-019-L3506 400-019-L3505 18 x 50	CB-L2692	
2548 LS	03 -	OM501LA OM502LA	G240-16 G280-16	AKB-L2204	430-701-L3086	430-019-L1775 18 x 50	CB-L1781	
2550 LS	03 -	OM501LA OM502LA	G240-16 G280-16	AKB-L2204	430-701-L3086	430-019-L1775 18 x 50	CB-L1781	
2550 LS	03 -	OM501LA OM502LA	G240-16 G280-16	AKB-L2084	400-702-L3504	400-019-L3506 400-019-L3505 18 x 50	CB-L2692	
2550 LS	03 -	OM501LA OM502LA	G240-16 G280-16	AKB-L2084	400-702-L3504	400-019-L3506 400-019-L3505 18 x 50	CB-L2692	
2550 LS	03 -	OM501LA OM502LA	G240-16 G280-16	AKB-L2084	400-702-L3504	400-019-L3506 400-019-L3505 18 x 50	CB-L2692	
2551 LS	03 -	OM501LA OM502LA	G240-16 G280-16	AKB-L2204	430-701-L3086	430-019-L1775 18 x 50	CB-L1781	
2551 LS	03 -	OM501LA OM502LA	G240-16 G280-16	AKB-L2084	400-702-L3504	400-019-L3506 400-019-L3505 18 x 50	CB-L2692	
2551 LS	03 -	OM501LA OM502LA	G240-16 G280-16	AKB-L2084	400-702-L3504	400-019-L3506 400-019-L3505 18 x 50	CB-L2692	
2551 LS	03 -	OM501LA OM502LA	G240-16 G280-16	AKB-L2084	400-702-L3504	400-019-L3506 400-019-L3505 18 x 50	CB-L2692	
2553	97-	OM502LA		AKB-L2084	400-702-L3504	400-019-L3506 400-019-L3505 18 x 50	CB-L2692	
2553	10/96-03	OM501LA	G240-16	AKB-L2204	430-701-L3086	430-019-L1775 18 x 50	CB-L1781	
2553	10/96-03	OM502LA	G240-16	AKB-L2084	400-702-L3504	400-019-L3506 400-019-L3505 18 x 50	CB-L2692	
2553	10/96-03	OM502LA	G240-16	AKB-L2204	430-701-L3086	430-019-L1775 18 x 50	CB-L1781	
2554	03 -	OM501LA OM502LA	G240-16 G280-16	AKB-L2084	400-702-L3504	400-019-L3506 400-019-L3505 18 x 50	CB-L2692	
2554	03 -	OM501LA OM502LA	G240-16 G280-16	AKB-L2084	400-702-L3504	400-019-L3506 400-019-L3505 18 x 50	CB-L2692	
2554	03 -	OM501LA OM502LA	G240-16 G280-16	AKB-L2084	400-702-L3504	400-019-L3506 400-019-L3505 18 x 50	CB-L2692	
2555 LS	03 -	OM502LA	G231-16	AKB-L2204	430-701-L3086	430-019-L1775 18 x 50	CB-L1781	
2555 LS	03 -	OM502LA	G231-16	AKB-L2204	430-701-L3086	430-019-L1775 18 x 50	CB-L1781	
2555 LS	03 -	OM502LA	G231-16	AKB-L2204	430-701-L3086	430-019-L1775 18 x 50	CB-L1781	
2555 L	03 -	OM502LA	G231-16	AKB-L2084	400-702-L3504	400-019-L3506 400-019-L3505 18 x 50	CB-L2692	
2557	98-00	OM502LA		AKB-L2084	400-702-L3504	400-019-L3506 400-019-L3505 18 x 50	CB-L2692	
2557	98-00	OM502LA		AKB-L2204	430-701-L3086	430-019-L1775 18 x 50	CB-L1781	
2632	03-	OM501LA	G211-16	AKB-L2204	430-701-L3086	430-019-L1775 18 x 50	CB-L1781	
2632	03-	OM501LA	G211-16	AKB-L2204	430-701-L3086	430-019-L1775 18 x 50	CB-L1781	

 Vehicle	Year	 Engine	 Gearbox	 LIPE Kit No.	 LIPE cover	 LIPE Disc	 LIPE Bearing	Notes
MERCEDES BENZ Cont'd								
2632	03-	OM501LA	G211-16	AKB-L2084	400-702-L3504	400-019-L3506 400-019-L3505 18 x 50	CB-L2692	
2632	03-	OM501LA	G211-16	AKB-L2204	430-701-L3086	430-019-L1775 18 x 50	CB-L1781	
2632 K	03-	OM501LA	G211-16	AKB-L2204	430-701-L3086	430-019-L1775 18 x 50	CB-L1781	
2632 K	03-	OM501LA	G211-16	AKB-L2084	400-702-L3504	400-019-L3506 400-019-L3505 18 x 50	CB-L2692	
2632 K	03-	OM501LA	G211-16	AKB-L3615	430-701-L3086	430-019-L1775 18 x 50	CB-L2693	
2632 K	03-	OM501LA	G211-16	AKB-L2084	400-702-L3504	400-019-L3506 400-019-L3505 18 x 50	CB-L2692	
2632 K	03-	OM501LA	G211-16	AKB-L2084	400-702-L3504	400-019-L3506 400-019-L3505 18 x 50	CB-L2692	
2636 K	03-	OM501LA	G211-16	AKB-L2204	430-701-L3086	430-019-L1775 18 x 50	CB-L1781	
2636 K	03-	OM501LA	G211-16	AKB-L2084	400-702-L3504	400-019-L3506 400-019-L3505 18 x 50	CB-L2692	
2636 K	03-	OM501LA	G211-16	AKB-L3615	430-701-L3086	430-019-L1775 18 x 50	CB-L2693	
2636 K	03-	OM501LA	G211-16	AKB-L2084	400-702-L3504	400-019-L3506 400-019-L3505 18 x 50	CB-L2692	
2636 K	03-	OM501LA	G211-16	AKB-L2204	430-701-L3086	430-019-L1775 18 x 50	CB-L1781	
2636 K	03-	OM501LA	G211-16	AKB-L2084	400-702-L3504	400-019-L3506 400-019-L3505 18 x 50	CB-L2692	
2636 K	03-	OM501LA	G211-16	AKB-L2084	400-702-L3504	400-019-L3506 400-019-L3505 18 x 50	CB-L2692	
2636 K	03-	OM501LA	G211-16	AKB-L2084	400-702-L3504	400-019-L3506 400-019-L3505 18 x 50	CB-L2692	
2636	03-	OM501LA	G211-16	AKB-L2204	430-701-L3086	430-019-L1775 18 x 50	CB-L1781	
2636	03-	OM501LA	G211-16	AKB-L2204	430-701-L3086	430-019-L1775 18 x 50	CB-L1781	
2636 L	03-	OM501LA	G211-16	AKB-L2084	400-702-L3504	400-019-L3506 400-019-L3505 18 x 50	CB-L2692	
2640	98-03	OM501LA	G210-16	AKB-L2204	430-701-L3086	430-019-L1775 18 x 50	CB-L1781	
2640	98-03	OM501LA	G210-16	AKB-L2084	400-702-L3504	400-019-L3506 400-019-L3505 18 x 50	CB-L2692	
2640 S	98-03	OM501LA	G210-16	AKB-L2204	430-701-L3086	430-019-L1775 18 x 50	CB-L1781	
2641 K	03 -	OM502LA	G240-16	AKB-L2204	430-701-L3086	430-019-L1775 18 x 50	CB-L1781	
2641 K	03 -	OM502LA	G240-16	AKB-L2084	400-702-L3504	400-019-L3506 400-019-L3505 18 x 50	CB-L2692	
2641 K	03 -	OM502LA	G240-16	AKB-L3615	430-701-L3086	430-019-L1775 18 x 50	CB-L2693	
2641 K	03 -	OM502LA	G240-16	AKB-L2084	400-702-L3504	400-019-L3506 400-019-L3505 18 x 50	CB-L2692	
2641	03-	OM501LA	G240-16	AKB-L2204	430-701-L3086	430-019-L1775 18 x 50	CB-L1781	
2641	03-	OM501LA	G240-16	AKB-L2204	430-701-L3086	430-019-L1775 18 x 50	CB-L1781	
2641	03-	OM501LA	G240-16	AKB-L2084	400-702-L3504	400-019-L3506 400-019-L3505 18 x 50	CB-L2692	
2643 S	98-03	OM501LA	G210-16	AKB-L2204	430-701-L3086	430-019-L1775 18 x 50	CB-L1781	
2643 S	98-03	OM501LA	G210-16	AKB-L2084	400-702-L3504	400-019-L3506 400-019-L3505 18 x 50	CB-L2692	



 Vehicle	Year	 Engine	 Gearbox	 LIPE Kit No.	 LIPE cover	 LIPE Disc	 LIPE Bearing	Notes
MERCEDES BENZ Cont'd								
2643 S	98-03	OM502LA	G210-16	AKB-L2204	430-701-L3086	430-019-L1775 18 x 50	CB-L1781	
2644	03-	OM501LA	G240-16	AKB-L2204	430-701-L3086	430-019-L1775 18 x 50	CB-L1781	
2644	03-	OM501LA	G240-16	AKB-L2204	430-701-L3086	430-019-L1775 18 x 50	CB-L1781	
2644	03-	OM501LA	G240-16	AKB-L2084	400-702-L3504	400-019-L3506 400-019-L3505 18 x 50	CB-L2692	
2644 S, LS	03-	OM501LA	G240-16	AKB-L2204	430-701-L3086	430-019-L1775 18 x 50	CB-L1781	
2644 S, LS	03-	OM501LA	G210-16	AKB-L2204	430-701-L3086	430-019-L1775 18 x 50	CB-L1781	
2644 S, LS	03-	OM501LA	G210-16	AKB-L3615	430-701-L3086	430-019-L1775 18 x 50	CB-L2693	
2644 S, LS	03-	OM501LA	G210-16	AKB-L2084	400-702-L3504	400-019-L3506 400-019-L3505 18 x 50	CB-L2692	
2646	03-	OM501LA	G240-16	AKB-L2204	430-701-L3086	430-019-L1775 18 x 50	CB-L1781	
2646	03-	OM501LA	G240-16	AKB-L2204	430-701-L3086	430-019-L1775 18 x 50	CB-L1781	
2646	03-	OM501LA	G240-16	AKB-L2084	400-702-L3504	400-019-L3506 400-019-L3505 18 x 50	CB-L2692	
2646 S, LS	03-	OM501LA	G240-16	AKB-L2204	430-701-L3086	430-019-L1775 18 x 50	CB-L1781	
2646 S, LS	03-	OM501LA	G240-16	AKB-L2084	400-702-L3504	400-019-L3506 400-019-L3505 18 x 50	CB-L2692	
2646 S, LS	03-	OM501LA	G240-16	AKB-L3615	430-701-L3086	430-019-L1775 18 x 50	CB-L2693	
2646 S, LS	03-	OM501LA	G240-16	AKB-L2084	400-702-L3504	400-019-L3506 400-019-L3505 18 x 50	CB-L2692	
2650	03-	OM502LA	G240-16	AKB-L2204	430-701-L3086	430-019-L1775 18 x 50	CB-L1781	
2650 S, LS	03-	OM502LA	G240-16	AKB-L2204	430-701-L3086	430-019-L1775 18 x 50	CB-L1781	
2650	03-	OM502LA	G240-16	AKB-L2084	400-702-L3504	400-019-L3506 400-019-L3505 18 x 50	CB-L2692	
2650	03-	OM502LA	G240-16	AKB-L2204	430-701-L3086	430-019-L1775 18 x 50	CB-L1781	
2650 S, LS	03-	OM502LA	G240-16	AKB-L2084	400-702-L3504	400-019-L3506 400-019-L3505 18 x 50	CB-L2692	
2650 S, LS	03-	OM502LA	G240-16	AKB-L2084	400-702-L3504	400-019-L3506 400-019-L3505 18 x 50	CB-L2692	
2651 S, LS	03-	OM502LA	G240-16 G280-16	AKB-L2204	430-701-L3086	430-019-L1775 18 x 50	CB-L1781	
2651 S, LS	03-	OM502LA	G240-16 G280-16	AKB-L2084	400-702-L3504	400-019-L3506 400-019-L3505 18 x 50	CB-L2692	
2651 S, LS	03-	OM502LA	G240-16 G280-16	AKB-L2084	400-702-L3504	400-019-L3506 400-019-L3505 18 x 50	CB-L2692	
2654	03-	OM502LA	G240-16	AKB-L2204	430-701-L3086	430-019-L1775 18 x 50	CB-L1781	
2654 S, LS	03-	OM502LA	G240-16	AKB-L2204	430-701-L3086	430-019-L1775 18 x 50	CB-L1781	
2654	03-	OM502LA	G240-16	AKB-L2084	400-702-L3504	400-019-L3506 400-019-L3505 18 x 50	CB-L2692	
2654	03-	OM502LA	G240-16	AKB-L2204	430-701-L3086	430-019-L1775 18 x 50	CB-L1781	









 Vehicle	Year	 Engine	 Gearbox	 LIPE Kit No.	 LIPE cover	 LIPE Disc	 LIPE Bearing	Notes
MERCEDES BENZ Cont'd								
2654 S, LS	03-	OM502LA	G240-16	AKB-L2084	400-702-L3504	400-019-L3506 400-019-L3505 18 x 50	CB-L2692	
2654 S, LS	03-	OM502LA	G240-16	AKB-L2084	400-702-L3504	400-019-L3506 400-019-L3505 18 x 50	CB-L2692	
3241	03-	OM502LA	G240-16	AKB-L2204	430-701-L3086	430-019-L1775 18 x 50	CB-L1781	
3241	03-	OM502LA	G240-16	AKB-L2084	400-702-L3504	400-019-L3506 400-019-L3505 18 x 50	CB-L2692	
3331 AK	10/96-03	OM502LA	G210-16	AKB-L2204	430-701-L3086	430-019-L1775 18 x 50	CB-L1781	
3332 AK	03-	OM502LA	G240-16	AKB-L2204	430-701-L3086	430-019-L1775 18 x 50	CB-L1781	
3332 AK	03-	OM502LA	G240-16	AKB-L2084	400-702-L3504	400-019-L3506 400-019-L3505 18 x 50	CB-L2692	
3332 AK	03-	OM502LA	G240-16	AKB-L3615	430-701-L3086	430-019-L1775 18 x 50	CB-L2693	
3332 AK	03-	OM502LA	G240-16	AKB-L2084	400-702-L3504	400-019-L3506 400-019-L3505 18 x 50	CB-L2692	
3343	98- 03	OM501LA	G240-16	AKB-L2204	430-701-L3086	430-019-L1775 18 x 50	CB-L1781	
3343	98- 03	OM501LA	G240-16	AKB-L2084	400-702-L3504	400-019-L3506 400-019-L3505 18 x 50	CB-L2692	
3343	98-	OM501LA		AKB-L2084	400-702-L3504	400-019-L3506 400-019-L3505 18 x 50	CB-L2692	
3343	98- 03	OM502LA	G240-16	AKB-L2204	430-701-L3086	430-019-L1775 18 x 50	CB-L1781	
3346 S, LS	03-	OM502LA	G240-16	AKB-L2204	430-701-L3086	430-019-L1775 18 x 50	CB-L1781	
3346 S, LS	03-	OM502LA	G240-16	AKB-L2084	400-702-L3504	400-019-L3506 400-019-L3505 18 x 50	CB-L2692	
3346 S, LS	03-	OM502LA	G240-16	AKB-L3615	430-701-L3086	430-019-L1775 18 x 50	CB-L2693	
3346 S, LS	03-	OM502LA	G240-16	AKB-L2084	400-702-L3504	400-019-L3506 400-019-L3505 18 x 50	CB-L2692	
3348 S	98- 03	OM501LA	G240-16	AKB-L2204	430-701-L3086	430-019-L1775 18 x 50	CB-L1781	
3348 S	98- 03	OM502LA	G240-16	AKB-L2084	400-702-L3504	400-019-L3506 400-019-L3505 18 x 50	CB-L2692	
3348 S	98- 03	OM502LA	G240-16	AKB-L2204	430-701-L3086	430-019-L1775 18 x 50	CB-L1781	
3348 S	03 -	OM501LA OM502LA	G240-16	AKB-L2204	430-701-L3086	430-019-L1775 18 x 50	CB-L1781	
3348 S	03 -	OM501LA OM502LA	G240-16	AKB-L2084	400-702-L3504	400-019-L3506 400-019-L3505 18 x 50	CB-L2692	
3348 S	03 -	OM501LA OM502LA	G240-16	AKB-L2084	400-702-L3504	400-019-L3506 400-019-L3505 18 x 50	CB-L2692	
3350 S	03 -	OM501LA OM502LA	G240-16	AKB-L2204	430-701-L3086	430-019-L1775 18 x 50	CB-L1781	
3350 S	03 -	OM501LA OM502LA	G240-16	AKB-L2084	400-702-L3504	400-019-L3506 400-019-L3505 18 x 50	CB-L2692	
3350 S	03 -	OM501LA OM502LA	G240-16	AKB-L2084	400-702-L3504	400-019-L3506 400-019-L3505 18 x 50	CB-L2692	
3351 S	03 -	OM501LA OM502LA	G240-16	AKB-L2204	430-701-L3086	430-019-L1775 18 x 50	CB-L1781	







 Vehicle	 Year	 Engine	 Gearbox	 LIPE Kit No.	 LIPE cover	 LIPE Disc	 LIPE Bearing	Notes
MERCEDES BENZ Cont'd								
3351 S	03 -	OM501LA OM502LA	G240-16	AKB-L2084	400-702-L3504	400-019-L3506 400-019-L3505 18 x 50	CB-L2692	
3351 S	03 -	OM501LA OM502LA	G240-16	AKB-L2084	400-702-L3504	400-019-L3506 400-019-L3505 18 x 50	CB-L2692	
Atego								
815	98-04	OM904LA	ZF S5-42	AKB-L2283	362-071-L3143	362-019-L3134 18 x 40	CB-L3416	
815	98-04	OM904LA	ZF S5-42	AKB-L3606	362-071-L3143	362-019-L3134 18 x 40	CB-L3417	
815	98-04	OM906LA	Mercedes G85-6	AKB-L2983	395-071-L3096	395-019-L3125 18 x 40		
815	98-04	OM906LA	Mercedes G85-6	AKB-L3604	395-071-L3096	395-019-L3125 18 x 40	CB-L3104	
815	98-04	OM904LA	Mercedes G56-6 G 60 -6	AKB-L2984	362-071-L3143	362-019-L3134 18 x 40		
816	10/04-	OM904LA	Mercedes G56-6	AKB-L2984	362-071-L3143	362-019-L3134 18 x 40		
817	98-04	OM904LA	Mercedes G60-6	AKB-L2984	362-071-L3143	362-019-L3134 18 x 40		
817	98-04	OM904LA	Mercedes G60-6	AKB-L3606	362-071-L3143	362-019-L3134 18 x 40	CB-L3417	
817	98-04	OM906LA	Mercedes G85-6	AKB-L2983	395-071-L3096	395-019-L3125 18 x 40		
817	98-04	OM906LA	Mercedes G85-6	AKB-L3604	395-071-L3096	395-019-L3125 18 x 40	CB-L3104	
818	02-	OM904LA	Mercedes G60-6	AKB-L2984	362-071-L3143	362-019-L3134 18 x 40		
818	02-	OM904LA	Mercedes G60-6	AKB-L3606	362-071-L3143	362-019-L3134 18 x 40	CB-L3417	
818	10/04 -	OM904LA	Mercedes G60-6	AKB-L2984	362-071-L3143	362-019-L3134 18 x 40		
822	10/04 -	OM924LA	Mercedes G85-6	AKB-L2983	395-071-L3096	395-019-L3125 18 x 40		
823	02-04	OM906LA	Mercedes G85-6	AKB-L2983	395-071-L3096	395-019-L3125 18 x 40		
823	02-04	OM906LA	Mercedes G85-6	AKB-L3604	395-071-L3096	395-019-L3125 18 x 40	CB-L3104	
823	10/04-	OM906LA	Mercedes G85-6	AKB-L2983	395-071-L3096	395-019-L3125 18 x 40		
824	10/04-	OM906LA	Mercedes G85-6	AKB-L2983	395-071-L3096	395-019-L3125 18 x 40		
917	98-04	OM904LA	Mercedes G60-6	AKB-L2984	362-071-L3143	362-019-L3134 18 x 40		
917	98-04	OM904LA	Mercedes G60-6	AKB-L3606	362-071-L3143	362-019-L3134 18 x 40	CB-L3417	
917	98-04	OM906LA	Mercedes G85-6	AKB-L2983	395-071-L3096	395-019-L3125 18 x 40		
917	98-04	OM906LA	Mercedes G85-6	AKB-L3604	395-071-L3096	395-019-L3125 18 x 40	CB-L3104	
918	02-	OM904LA	Mercedes G60-6	AKB-L2984	362-071-L3143	362-019-L3134 18 x 40		
918	02-	OM904LA	Mercedes G60-6	AKB-L3606	362-071-L3143	362-019-L3134 18 x 40	CB-L3417	
918	10/04-	OM904LA	Mercedes G56-6	AKB-L2984	362-071-L3143	362-019-L3134 18 x 40		
922	10/04-	OM924LA	Mercedes G85-6	AKB-L2983	395-071-L3096	395-019-L3125 18 x 40		
923	02-04	OM906LA	Mercedes G85-6	AKB-L2983	395-071-L3096	395-019-L3125 18 x 40		
923	02-04	OM906LA	Mercedes G85-6	AKB-L3604	395-071-L3096	395-019-L3125 18 x 40	CB-L3104	
923	02-04	OM906LA	Mercedes G85-6	AKB-L2983	395-071-L3096	395-019-L3125 18 x 40		

 Vehicle	Year	 Engine	 Gearbox	 LIPE Kit No.	 LIPE cover	 LIPE Disc	 LIPE Bearing	Notes
MERCEDES BENZ Cont'd								
924	02-04	OM906LA	Mercedes G85-6	AKB-L2983	395-071-L3096	395-019-L3125 18 x 40		
1017, A	98-04	OM904LA	Mercedes G60-6	AKB-L2984	362-071-L3143	362-019-L3134 18 x 40		
1017, A	98-04	OM904LA	Mercedes G60-6	AKB-L3606	362-071-L3143	362-019-L3134 18 x 40	CB-L3417	
1017	98-04	OM906LA	Mercedes G85-6	AKB-L2983	395-071-L3096	395-019-L3125 18 x 40		
1017	98-04	OM906LA	Mercedes G85-6	AKB-L3604	395-071-L3096	395-019-L3125 18 x 40	CB-L3104	
1018, A	02-04	OM904LA	Mercedes G60-6	AKB-L2984	362-071-L3143	362-019-L3134 18 x 40		
1018, A	02-04	OM904LA	Mercedes G60-6	AKB-L3606	362-071-L3143	362-019-L3134 18 x 40	CB-L3417	
1018, A	10/04-	OM904LA	Mercedes G60-6	AKB-L2984	362-071-L3143	362-019-L3134 18 x 40		
1022	10/04-	OM924LA	Mercedes G85-6	AKB-L2983	395-071-L3096	395-019-L3125 18 x 40		
1023	02-04	OM906LA	Mercedes G85-6	AKB-L2983	395-071-L3096	395-019-L3125 18 x 40		
1023	02-04	OM906LA	Mercedes G85-6	AKB-L3604	395-071-L3096	395-019-L3125 18 x 40	CB-L3104	
1023, K	10/04-	OM906LA	Mercedes G85-6	AKB-L2983	395-071-L3096	395-019-L3125 18 x 40		
1024	10/04-	OM906LA	Mercedes G85-6	AKB-L2983	395-071-L3096	395-019-L3125 18 x 40		
1217	98-04	OM904LA	Mercedes G60-6	AKB-L2984	362-071-L3143	362-019-L3134 18 x 40		
1217	98-04	OM904LA	Mercedes G60-6	AKB-L3606	362-071-L3143	362-019-L3134 18 x 40	CB-L3417	
1217	98-04	OM906LA	Mercedes G85-6	AKB-L2983	395-071-L3096	395-019-L3125 18 x 40		
1217	98-04	OM906LA	Mercedes G85-6	AKB-L3604	395-071-L3096	395-019-L3125 18 x 40	CB-L3104	
1218	02-	OM904LA	Mercedes G60-6	AKB-L2984	362-071-L3143	362-019-L3134 18 x 40		
1218	02-	OM904LA	Mercedes G60-6	AKB-L3606	362-071-L3143	362-019-L3134 18 x 40	CB-L3417	
1218, nR	10/04-	OM904LA	Mercedes G60-6	AKB-L2984	362-071-L3143	362-019-L3134 18 x 40		
1222, nR	10/04-	OM924LA	Mercedes G85-6	AKB-L2983	395-071-L3096	395-019-L3125 18 x 40		
1223	98-	OM906LA	Mercedes G85-6	AKB-L2983	395-071-L3096	395-019-L3125 18 x 40		
1223	98-04	OM906LA	Mercedes G85-6	AKB-L3604	395-071-L3096	395-019-L3125 18 x 40	CB-L3104	
1223, nR	10/04-	OM906LA	Mercedes G85-6	AKB-L2983	395-071-L3096	395-019-L3125 18 x 40		
1317, A, K	98-04	OM904LA	Mercedes G60-6	AKB-L2984	362-071-L3143	362-019-L3134 18 x 40		
1317, A, K	98-04	OM904LA	Mercedes G60-6	AKB-L3606	362-071-L3143	362-019-L3134 18 x 40	CB-L3417	
1317, A, K	98-04	OM906LA	Mercedes G85-6	AKB-L2983	395-071-L3096	395-019-L3125 18 x 40		
1318, K, LKO	02-	OM904LA	Mercedes G60-6	AKB-L2984	362-071-L3143	362-019-L3134 18 x 40		
1318 K, LKO	02-	OM904LA	Mercedes G60-6	AKB-L3606	362-071-L3143	362-019-L3134 18 x 40	CB-L3417	
1318, A, K, LKO	10/04-	OM904LA	Mercedes G60-6	AKB-L2984	362-071-L3143	362-019-L3134 18 x 40		
1322, K, LS	10/04-	OM924LA	Mercedes G85-6	AKB-L2983	395-071-L3096	395-019-L3125 18 x 40		
1323, K, LS	98-04	OM906LA	Mercedes G85-6	AKB-L2983	395-071-L3096	395-019-L3125 18 x 40		
1323, K, LS	98-04	OM906LA	Mercedes G85-6	AKB-L3604	395-071-L3096	395-019-L3125 18 x 40	CB-L3104	

 Vehicle	 Year	 Engine	 Gearbox	 LIPE Kit No.	 LIPE cover	 LIPE Disc	 LIPE Bearing	Notes
MERCEDES BENZ Cont'd								
1323, K, LS	10/04-	OM906LA	Mercedes G85-6	AKB-L2983	395-071-L3096	395-019-L3125 18 x 40		
1324, K	10/04-	OM906LA	Mercedes G85-6	AKB-L2983	395-071-L3096	395-019-L3125 18 x 40		
1324, LS	10/04-	OM906LA	Mercedes G131-9	AKB-L2277	395-071-L3095	395-019-L3099 18 x 40		
1328, LS	02-04	OM906LA	Mercedes G100-12	AKB-L2277	395-071-L3095	395-019-L3099 18 x 40		
1328, LS	10/04-	OM906LA	Mercedes G100-12	AKB-L3605	395-071-L3095	395-019-L3099 18 x 40	CB-L3104	
1328, LS	10/04-	OM906LA	Mercedes G100-12	AKB-L2277	395-071-L3095	395-019-L3099 18 x 40		
1329, LS, F	10/04-	OM904LA	Mercedes G131-9	AKB-L2277	395-071-L3095	395-019-L3099 18 x 40		
1518	02-04	OM904LA	Mercedes G60-6	AKB-L2984	362-071-L3143	362-019-L3134 18 x 40		
1518	02-04	OM904LA	Mercedes G60-6	AKB-L3606	362-071-L3143	362-019-L3134 18 x 40	CB-L3417	
1518, K	10/04-	OM904LA	Mercedes G60-6	AKB-L2984	362-071-L3143	362-019-L3134 18 x 40		
1522, K	10/04-	OM924LA	Mercedes G85-6	AKB-L2983	395-071-L3096	395-019-L3125 18 x 40		
1523, K	98-04	OM906LA	Mercedes G85-6	AKB-L2983	395-071-L3096	395-019-L3125 18 x 40		
1523, K	98-04	OM906LA	Mercedes G85-6	AKB-L3604	395-071-L3096	395-019-L3125 18 x 40	CB-L3104	
1523, K	10/04-	OM906LA	Mercedes G85-6	AKB-L2983	395-071-L3096	395-019-L3125 18 x 40		
1524, K	10/04-	OM906LA	Mercedes G85-6	AKB-L2983	395-071-L3096	395-019-L3125 18 x 40		
1528	02-04	OM906LA	Mercedes G100-12	AKB-L2277	395-071-L3095	395-019-L3099 18 x 40		
1528	02-04	OM906LA	Mercedes G100-12	AKB-L3605	395-071-L3095	395-019-L3099 18 x 40	CB-L3104	
1528	10/04-	OM906LA	Mercedes G100-12	AKB-L2277	395-071-L3095	395-019-L3099 18 x 40		
1618, K	02-04	OM904LA	Mercedes G60-6	AKB-L2984	362-071-L3143	362-019-L3134 18 x 40		
1618, K	02-04	OM904LA	Mercedes G60-6	AKB-L3606	362-071-L3143	362-019-L3134 18 x 40	CB-L3417	
1618, K	10/04-	OM904LA	Mercedes G60-6	AKB-L2984	362-071-L3143	362-019-L3134 18 x 40		
1622, K	10/04-	OM924LA	Mercedes G85-6	AKB-L2983	395-071-L3096	395-019-L3125 18 x 40		
1623, K	02-04	OM906LA	Mercedes G85-6	AKB-L2983	395-071-L3096	395-019-L3125 18 x 40		
1623, K	10/04-	OM906LA	Mercedes G85-6	AKB-L3604	395-071-L3096	395-019-L3125 18 x 40	CB-L3104	
1623	10/04-	OM906LA	Mercedes G85-6	AKB-L2983	395-071-L3096	395-019-L3125 18 x 40		
1624, K	10/04-	OM906LA	Mercedes G85-6	AKB-L2983	395-071-L3096	395-019-L3125 18 x 40		
1628	02-04	OM906LA	Mercedes G100-12	AKB-L2277	395-071-L3095	395-019-L3099 18 x 40		
1628	02-04	OM906LA	Mercedes G100-12	AKB-L3605	395-071-L3095	395-019-L3099 18 x 40	CB-L3104	
1628	10/04-	OM906LA	Mercedes G100-12	AKB-L2277	395-071-L3095	395-019-L3099 18 x 40		
1629	10/04-	OM906LA	Mercedes G131-09	AKB-L2277	395-071-L3095	395-019-L3099 18 x 40		
1823, AK, K, L, LL	98-04	OM906LA	Mercedes G85-6	AKB-L2983	395-071-L3096	395-019-L3125 18 x 40		
1823, AK, K, L, LL	98-04	OM906LA	Mercedes G85-6	AKB-L3604	395-071-L3096	395-019-L3125 18 x 40	CB-L3104	
1823, AK, K, L, LL	98-04	OM906LA	Mercedes G100-12	AKB-L2277	395-071-L3095	395-019-L3099 18 x 40		

 Vehicle	 Year	 Engine	 Gearbox	 LIPE Kit No.	 LIPE cover	 LIPE Disc	 LIPE Bearing	Notes
MERCEDES BENZ Cont'd								
1823, AK, K, L, LL	98-04	OM906LA	Mercedes G100-12	AKB-L3605	395-071-L3095	395-019-L3099 18 x 40	CB-L3104	
1823, AK, K, L, LL	98-04		Mercedes G211-16	AKB-L2204	430-701-L3086	430-019-L1775 18 x 50	CB-L1781	
1828, AK, K, L, LL, LS	98-04	OM906LA	Mercedes G100-12	AKB-L2277	395-071-L3095	395-019-L3099 18 x 40		
1828, AK, K, L, LL, LS	98-04	OM906LA	Mercedes G100-12	AKB-L3605	395-071-L3095	395-019-L3099 18 x 40	CB-L3104	
1828, AK, K, L, LL, LS	98-04	OM906LA	Mercedes G211-16	AKB-L2204	430-701-L3086	430-019-L1775 18 x 50	CB-L1781	
2528, L, LL	98-04	OM906LA	Mercedes G100-12	AKB-L2277	395-071-L3095	395-019-L3099 18 x 40		
2528, L, LL	98-04	OM906LA	Mercedes G100-12	AKB-L3605	395-071-L3095	395-019-L3099 18 x 40	CB-L3104	
2528, L, LL	98-04	OM906LA	Mercedes G211-16	AKB-L2204	430-701-L3086	430-019-L1775 18 x 50	CB-L1781	
2528 L, LL	98-04	OM926LA	Mercedes G211-16	AKB-L3615	430-701-L3086	430-019-L1775 18 x 50	CB-L2693	
2628, B, K	98-04	OM906LA	Mercedes G100-12	AKB-L2277	395-071-L3095	395-019-L3099 18 x 40		
2628, B, K	98-04	OM906LA	Mercedes G100-12	AKB-L3605	395-071-L3095	395-019-L3099 18 x 40	CB-L3104	
2628, B, K	98-04	OM906LA	Mercedes G211-16	AKB-L2204	430-701-L3086	430-019-L1775 18 x 50	CB-L1781	
2628, B, K	98-04	OM926LA	Mercedes G211-16	AKB-L3615	430-701-L3086	430-019-L1775 18 x 50	CB-L2693	
Axor								
1823, K, LS	10/04-	QM902 QM906	Mercedes G85-6	AKB-L2277	395-071-L3095	395-019-L3099 18 x 40		
1823, K, LS	10/04-	QM902 QM906		AKB-L2204	430-701-L3086	430-019-L1775 18 x 50	CB-L1781	
1823, K, LS	10/04-	QM902 QM906		AKB-L2277	395-071-L3095	395-019-L3099 18 x 40		
1823, AK	10/04-	QM902 QM906		AKB-L2204	430-701-L3086	430-019-L1775 18 x 50	CB-L1781	
1824, K, LS	10/04-	QM902 QM906	Mercedes G85-6 G131-9	AKB-L2277	395-071-L3095	395-019-L3099 18 x 40		
1824, K, LS	10/04-	QM902 QM906	Mercedes G85-6 G131-9	AKB-L2204	430-701-L3086	430-019-L1775 18 x 50	CB-L1781	
1824, K, LS	10/04-	QM902 QM906	Mercedes G85-6	AKB-L2277	395-071-L3095	395-019-L3099 18 x 40		
1824, AK	10/04-	QM902 QM906	Mercedes G85-6	AKB-L2204	430-701-L3086	430-019-L1775 18 x 50	CB-L1781	
1828, K, LS	10/04-	QM902 QM906	Mercedes G85-6	AKB-L2277	395-071-L3095	395-019-L3099 18 x 40		
1828, K, LS	10/04-	QM902 QM906		AKB-L2204	430-701-L3086	430-019-L1775 18 x 50	CB-L1781	
1828, K, LS	10/04-	QM902 QM906		AKB-L2277	395-071-L3095	395-019-L3099 18 x 40		
1828, AK	10/04-	QM902 QM906		AKB-L2204	430-701-L3086	430-019-L1775 18 x 50	CB-L1781	
1829, K, LS	10/04-	QM902 QM906	Mercedes G131-9	AKB-L2277	395-071-L3095	395-019-L3099 18 x 40		
1829, K, LS	10/04-	QM902 QM906	Mercedes G131-9	AKB-L2204	430-701-L3086	430-019-L1775 18 x 50	CB-L1781	
1829, K, LS	10/04-	QM902 QM906	Mercedes G131-9	AKB-L2277	395-071-L3095	395-019-L3099 18 x 40		
1829, AK	10/04-	QM902 QM906	Mercedes G131-9	AKB-L2204	430-701-L3086	430-019-L1775 18 x 50	CB-L1781	
1833, K, LS	10/04-	QM902 QM906	Mercedes G131-9	AKB-L2277	395-071-L3095	395-019-L3099 18 x 40		

 Vehicle	 Year	 Engine	 Gearbox	 LIPE Kit No.	 LIPE cover	 LIPE Disc	 LIPE Bearing	Notes
1833, K, LS	10/04-	QM902 QM906	Mercedes G131-9	AKB-L2204	430-701-L3086	430-019-L1775 18 x 50	CB-L1781	
1833, K, LS	10/04-	QM902 QM906	Mercedes G131-9	AKB-L2277	395-071-L3095	395-019-L3099 18 x 40		
1833, AK	10/04-	QM902 QM906	Mercedes G131-9	AKB-L2204	430-701-L3086	430-019-L1775 18 x 50	CB-L1781	
1835 LS	02-04	OM457LA	Mercedes G221-9	AKB-L2204	430-701-L3086	430-019-L1775 18 x 50	CB-L1781	
1836 LS	10/04-	OM457LA	Mercedes G221-9 G211-12	AKB-L2204	430-701-L3086	430-019-L1775 18 x 50	CB-L1781	
1840 LS	02-04	OM457LA	Mercedes G221-9	AKB-L2204	430-701-L3086	430-019-L1775 18 x 50	CB-L1781	
1840 LS	10/04-	OM457LA	Mercedes G221-9 G211-12	AKB-L2204	430-701-L3086	430-019-L1775 18 x 50	CB-L1781	
1843 LS	02-04	OM457LA	Mercedes G221-9	AKB-L2204	430-701-L3086	430-019-L1775 18 x 50	CB-L1781	
1843 LS	10/04-	OM457LA	Mercedes G221-9 G211-12	AKB-L2204	430-701-L3086	430-019-L1775 18 x 50	CB-L1781	
2528 L	10/04-	QM902 QM906		AKB-L2277	395-071-L3095	395-019-L3099 18 x 40		
2528 L	10/04-	QM902 QM906		AKB-L2204	430-701-L3086	430-019-L1775 18 x 50	CB-L1781	
2533 L	10/04-	OM926	Mercedes G131-9	AKB-L2277	395-071-L3095	395-019-L3099 18 x 40		
2533 L	10/04-	OM926	Mercedes G131-9	AKB-L2204	430-701-L3086	430-019-L1775 18 x 50	CB-L1781	
2535 LS	02-04	OM457LA	Mercedes G221-9	AKB-L2204	430-701-L3086	430-019-L1775 18 x 50	CB-L1781	
2540 LS	02-04	OM457LA	Mercedes G221-9	AKB-L2204	430-701-L3086	430-019-L1775 18 x 50	CB-L1781	
2543 LS	02-04	OM457LA	Mercedes G221-9	AKB-L2204	430-701-L3086	430-019-L1775 18 x 50	CB-L1781	
2628 K	10/04-	QM902 QM906	Mercedes G131-9	AKB-L2277	395-071-L3095	395-019-L3099 18 x 40		
2628 K	10/04-	QM902 QM906	Mercedes G131-9	AKB-L2204	430-701-L3086	430-019-L1775 18 x 50	CB-L1781	
2628 B	10/04-	QM902 QM906	Mercedes G131-9	AKB-L2277	395-071-L3095	395-019-L3099 18 x 40		
2628 B	10/04-	QM902 QM906	Mercedes G131-9	AKB-L2204	430-701-L3086	430-019-L1775 18 x 50	CB-L1781	
2628 B	10/04-	QM902 QM906	Mercedes G131-9	AKB-L3615	430-701-L3086	430-019-L1775 18 x 50	CB-L2693	
2629 K	10/04-	QM902 QM906	Mercedes G131-9	AKB-L2277	395-071-L3095	395-019-L3099 18 x 40		
2629 K	10/04-	QM902 QM906	Mercedes G131-9	AKB-L2204	430-701-L3086	430-019-L1775 18 x 50	CB-L1781	
2629 B	10/04-	QM902 QM906	Mercedes G131-9	AKB-L2277	395-071-L3095	395-019-L3099 18 x 40		
2629 B	10/04-	QM902 QM906	Mercedes G131-9	AKB-L2204	430-701-L3086	430-019-L1775 18 x 50	CB-L1781	
2629 B	10/04-	QM902 QM906	Mercedes G131-9	AKB-L3615	430-701-L3086	430-019-L1775 18 x 50	CB-L2693	
2633, B, K	10/04-	QM902 QM906	Mercedes G131-9	AKB-L2277	395-071-L3095	395-019-L3099 18 x 40		
2633, B, K	10/04-	QM902 QM906	Mercedes G131-9	AKB-L2204	430-701-L3086	430-019-L1775 18 x 50	CB-L1781	
3236 K	10/04-	OM457LA	Mercedes G221-9	AKB-L2204	430-701-L3086	430-019-L1775 18 x 50	CB-L1781	
3236 K	10/04-	OM457LA	Mercedes G221-9	AKB-L2084	400-702-L3504	400-019-L3506 400-019-L3505 18 x 50	CB-L2692	
3240 K	10/04-	OM457LA	Mercedes G221-9	AKB-L2204	430-701-L3086	430-019-L1775 18 x 50	CB-L1781	

 Vehicle	Year	 Engine	 Gearbox	 LIPE Kit No.	 LIPE cover	 LIPE Disc	 LIPE Bearing	Notes
MERCEDES BENZ Cont'd								
3240 K	10/04-	OM457LA	Mercedes G221-9	AKB-L2084	400-702-L3504	400-019-L3506 400-019-L3505 18 x 50	CB-L2692	
3243 K	10/04-	OM457LA	Mercedes G221-9	AKB-L2204	430-701-L3086	430-019-L1775 18 x 50	CB-L1781	
3243 K	10/04-	OM457LA	Mercedes G221-9	AKB-L2084	400-702-L3504	400-019-L3506 400-019-L3505 18 x 50	CB-L2692	
Econic								
1823 LL	98-	OM906LA		AKB-L2205	430-701-L3086	430-019-L1775 18 x 50	CB-L1781	
1828 LL	98-	OM906LA		AKB-L2205	430-701-L3086	430-019-L1775 18 x 50	CB-L1781	
2628 LL	98-	OM906LA		AKB-L2205	430-701-L3086	430-019-L1775 18 x 50	CB-L1781	
Vario								
614D	96-	OM904LA		AKB-L2984	362-071-L3143	362-019-L3134 18 x 40		
814D	96-	OM904LA	Mercedes	AKB-L2984	362-071-L3143	362-019-L3134 18 x 40		
814D	96-	OM904LA	ZF	AKB-L2283	362-071-L3143	362-019-L3134 18 x 40	CB-L3416	
800								
814	96-98	OM904LA	Mercedes	AKB-L2984	362-071-L3143	362-019-L3134 18 x 40		
814	96-98	OM904LA	ZF	AKB-L2283	362-071-L3143	362-019-L3134 18 x 40	CB-L3416	
814	96-98	OM904LA	Mercedes	AKB-L3154	362-071-L3143	362-019-L3134 18 x 40	CB-L3607	
814	96-98	OM904LA	ZF	AKB-L2283	362-071-L3143	362-019-L3134 18 x 40	CB-L3416	
817	96-98	OM904LA	Mercedes	AKB-L3154	362-071-L3143	362-019-L3134 18 x 40	CB-L3607	
817	96-98	OM904LA	Mercedes	AKB-L2984	362-071-L3143	362-019-L3134 18 x 40		
817	96-98	OM904LA	ZF	AKB-L2283	362-071-L3143	362-019-L3134 18 x 40	CB-L3416	
900								
917	96-98	OM904LA	Mercedes	AKB-L3154	362-071-L3143	362-019-L3134 18 x 40	CB-L3607	
917	96-98	OM904LA	ZF	AKB-L2283	362-071-L3143	362-019-L3134 18 x 40	CB-L3416	
1100								
1117	96-98	OM904LA	Mercedes	AKB-L3154	362-071-L3143	362-019-L3134 18 x 40	CB-L3607	
1117	96-98	OM904LA	Mercedes	AKB-L2984	362-071-L3143	362-019-L3134 18 x 40		
1117	96-98	OM904LA	ZF	AKB-L2283	362-071-L3143	362-019-L3134 18 x 40	CB-L3416	
1300								
1317	96-98	OM904LA	Mercedes	AKB-L3154	362-071-L3143	362-019-L3134 18 x 40	CB-L3607	
1317	96-98	OM904LA	ZF	AKB-L2283	362-071-L3143	362-019-L3134 18 x 40	CB-L3416	
1700								
1733	89-92	OM441		AKB-L2004	430-701-L2320	430-019-L2321 2" x 10	CB-L1977	
1735	88-92	OM442A		AKB-L2169			CB-L1977	
1748	Ch-92	OM442LA		AKB-L2208	430-701-L2320	430-019-L3040 2" x 10		



Vehicle

Year



Engine



Gearbox



LIPE Kit No.



LIPE cover



LIPE Disc

LIPE
Bearing

Notes

MERCEDES BENZ Cont'd**1800**

1827	92-99	OM401LA OM441LA		AKB-L2005	430-701-L2320	430-019-L2321 2" x 10	CB-L1977	
1827	92-99	OM401LA OM441LA		AKB-L2005	430-701-L2320	430-019-L2321 2" x 10	CB-L1977	
1831	92-97	OM401LA		AKB-L2004	430-701-L2320	430-019-L2321 2" x 10	CB-L1977	
1831	92-97	OM442A		AKB-L2169			CB-L1977	
1834	92-97	OM441LA		AKB-L2004	430-701-L2320	430-019-L2321 2" x 10	CB-L1977	
1838	92-97	OM402LA OM442LA		AKB-L2169			CB-L1977	
1844	Ch-97	OM442LA		AKB-L2169	430-701-L2320	430-019-L3040 2" x 10	CB-L1977	
1850	Ch-97	OM442LA		AKB-L2169	430-701-L2320	430-019-L3040 2" x 10	CB-L1977	

2400

2433	89-92	OM441		AKB-L2004	430-701-L2320	430-019-L2321 2" x 10	CB-L1977	
2435	88-92	OM442A		AKB-L2169 Prior Feb'93 AK-L1440				
2448	Ch-92	OM442LA		AKB-L2169	430-701-L2320	430-019-L3040 2" x 10	CB-L1977	

2500

2524	93-98	OM401LA OM441LA		AKB-L2005	430-701-L2320	430-019-L2321 2" x 10	CB-L1977	
2524	93-98	OM401LA OM441LA		AKB-L2004	430-701-L2320	430-019-L2321 2" x 10	CB-L1977	
2527	93-98	OM401LA OM441LA		AKB-L2005	430-701-L2320	430-019-L2321 2" x 10	CB-L1977	
2534	92-97	OM441LA		AKB-L2004	430-701-L2320	430-019-L2321 2" x 10	CB-L1977	
2538	92-97	OM402LA OM442LA		AKB-L2169			CB-L1977	
2544L,S	Ch-97	OM442LA		AKB-L2169	430-701-L2320	430-019-L3040 2" x 10	CB-L1977	
2550	Ch-97	OM442LA		AKB-L2169	430-701-L2320	430-019-L3040 2" x 10	CB-L1977	

2600

2631	92-96	OM401		AKB-L2004	430-701-L2320	430-019-L2321 2" x 10	CB-L1977	
2635	88-94	OM442A		AKB-L2169			CB-L1977	
2638	94-98	OM402 OM442		AKB-L2169			CB-L1977	
2644	Ch-98	OM440		AKB-L2169	430-701-L2320	430-019-L3040 2" x 10	CB-L1977	
2644	94-98	OM442		AKB-L2169			CB-L1977	

3200

3234	93-98	OM441LA		AKB-L2004	430-701-L2320	430-019-L2321 2" x 10	CB-L1977	
------	-------	---------	--	-----------	---------------	--------------------------	----------	--

3500

3538K	88-94	OM402LA		AKB-L2169			CB-L1977	
-------	-------	---------	--	-----------	--	--	----------	--

ONTOP UK

400		Cummins 6BT		LP-1931-634				Adaptor Kit AK-313 may be required
700		Cummins 6BT		LP-1931-634				Adaptor Kit AK-313 may be required
500-180		Cummins 6BTA		LP-L0969-644				



Vehicle

Year



Engine



Gearbox



LIPE Kit No.



LIPE cover



LIPE Disc

LIPE
Bearing

Notes

RENAULT V.I**Commando**

Mk2	81-89	Perkins 6.354		AK-L0904				
Kerax								
320	01-	dCi11G	ZF 8S-151 ZF 16S-151	AKB-L2713				
320	01-	dCi11G	ZF 8S-151 ZF 16S-151	AKB-L2895	430-701-L2882	430-019-L2885 2" x 10	CB-L2887	
340	97-	MIDR 06.20.45E/41	RVI B9 RVI B18	AKB-L2284				
340	00-	MIDR 06.20.45E/41	ZF 8S-151 ZF 16S-151 ZF 16S-221	AKB-L2713				
340	05/01 -	MIDR 06.20.45E/41	ZF 8S-151 ZF 16S-151 ZF 16S-221	AKB-L2894	430-701-L2882	430-019-L2886 2" -10	CB-L2887	
370	01-	dCi11E	ZF 16S-151	AKB-L2713				
370	01-	dCi11E	ZF 16S-151	AKB-L2895	430-701-L2882	430-019-L2885 2" x 10	CB-L2887	
370	01-	dCi11E	ZF 9S-109	AKB-L2891	430-701-L2882	430-019-L2884 1 3/4" x 10	CB-L2889	
385	97-	MIDR 06.23.56A/41	RVI B9 RVI B18	AKB-L2284				
385	00-	MIDR 06.23.56A/41	ZF 8S-151 ZF 16S-151 ZF 16S-221	AKB-L2713				
385	05/01 -	MIDR 06.23.56A/41	ZF 8S-151 ZF 16S-151 ZF 16S-221	AKB-L2895	430-701-L2882	430-019-L2885 2" x 10	CB-L2887	
400.32	00-	MIDR 06.23.56A/41	ZF 8S-151 ZF 16S-151 ZF 16S-221	AKB-L2713				
400.32		MIDR 06.23.56A/41	ZF 16S-151	AKB-L2895	430-701-L2882	430-019-L2885 2" x 10	CB-L2887	
420.32	01-	dCi11	ZF 16S-151	AKB-L2713				
420.32	05/01 -	dCi11	ZF 16S-151	AKB-L2895	430-701-L2882	430-019-L2885 2" x 10	CB-L2887	

Magnum

AE385Ti	92-96	MIDR 6.35.40L/3RVI B18		AKB-L2107				
AE420Ti	92-97	MIDR 06.35.40J RVI B18		AKB-L2107				
AE470.19	97-	Mack EE9	RVI B18	AKB-L2284				
AE470.22	97-99	MIDR 06.25.40	RVI B18	AKB-L2284				
AE470.23	97-99	MIDR 06.24.56C	RVI B18	AKB-L2284				
AE520.19	92-95	Mack EE9	RVI B18	AKB-L2107				
AE520	95-97	Mack EE9	RVI B18	AKB-L2284				

Magnum E. Tech

440.24	00 -	Mack E.Tech B46	ZF 16S-181 ZF 16S-221	AKB-L2713				
440.24	00 -	Mack E.Tech B46	ZF 16AS2601	AKB-L2893	430-701-L2882	430-019-L2885 2" x 10	CB-L1339	
440.26	01 -	Mack E.Tech B46	ZF 16S-181 ZF 16S-221	AKB-L2713				
440.26	01 -	Mack E.Tech B46	ZF 16AS2601	AKB-L2893	430-701-L2882	430-019-L2885 2" x 10	CB-L1339	
440.26	01 -	Mack E.Tech B46	ZF 16S-181 ZF 16S-221	AKB-L2895	430-701-L2882	430-019-L2885 2" x 10	CB-L2887	
480.26	01 -	Mack E.Tech C46	ZF 16S-181 ZF 16S-221	AKB-L2713				
480.26	01-02/03	Mack E.Tech C46	ZF 16S-181 ZF 16S-221	AKB-L2895	430-701-L2882	430-019-L2885 2" x 10	CB-L2887	
480.26	01-02/03	Mack E.Tech C46	ZF 16AS2601	AKB-L2893	430-701-L2882	430-019-L2885 2" x 10	CB-L1339	



Vehicle

Year



Engine



Gearbox



LIPE Kit No.



LIPE cover



LIPE Disc

LIPE
Bearing

Notes

RENAULT V.I Cont'd**Major**

420Ti	92-97	06.35.40J	RVI B18	AKB-L2107				
-------	-------	-----------	---------	-----------	--	--	--	--

Manager

340Ti	91-96	MIDR 06.20.45E	RVI B9, B18	AKB-L2107				
-------	-------	-------------------	-------------	-----------	--	--	--	--

Maxter

G300.26D	92-97	MIDR 06.20.45D	RVI B9, B18	AKB-L2107				
----------	-------	-------------------	-------------	-----------	--	--	--	--

G340Ti.32D	92-97	MIDR 06.20.45E	RVI B9, B18	AKB-L2107				
------------	-------	-------------------	-------------	-----------	--	--	--	--

Premium

300	96-	MIDR 06.20.45D4	RVI B9	AKB-L2284				
-----	-----	--------------------	--------	-----------	--	--	--	--

300	00-	MIDR 06.23.45A/41	ZF 16S-151 ZF 16S-181	AKB-L2713				
-----	-----	----------------------	--------------------------	-----------	--	--	--	--

300	96 -	MIDR 06.20.45D/41	ZF 9S-109 ZF 16S-109	AKB-L2891	430-701-L2882	430-019-L2884 1 3/4" x 10	CB-L2889	
-----	------	----------------------	-------------------------	-----------	---------------	------------------------------	----------	--

340	96-	MIDR 06.20.45E4	RVI B9	AKB-L2284				
-----	-----	--------------------	--------	-----------	--	--	--	--

340	00 -	MIDR 06.23.45E/41	ZF 16S-151 ZF 16S-181	AKB-L2713				
-----	------	----------------------	--------------------------	-----------	--	--	--	--

340	96 -	MIDR 06.20.45E/41	ZF 9S-109 ZF 16S-109	AKB-L2891	430-701-L2882	430-019-L2884 1 3/4" x 10	CB-L2889	
-----	------	----------------------	-------------------------	-----------	---------------	------------------------------	----------	--

340	9/99 -	MIDR 06.20.45E/41	ZF 8S-151 ZF 16S-151	AKB-L2894	430-701-L2882	430-019-L2886 2" x 10	CB-L2887	
-----	--------	----------------------	-------------------------	-----------	---------------	--------------------------	----------	--

385	96-	MIDR 06.23.56A/41	RVI B9	AKB-L2284				
-----	-----	----------------------	--------	-----------	--	--	--	--

385	00 -	MIDR 06.23.45A/41	ZF 16S-151 ZF 16S-181	AKB-L2713				
-----	------	----------------------	--------------------------	-----------	--	--	--	--

385	96 -	MIDR 06.23.56A/41	ZF 8S-151 ZF 16S-151 ZF 16S-181	AKB-L2895	430-701-L2882	430-019-L2885 2" x 10	CB-L2887	
-----	------	----------------------	---------------------------------------	-----------	---------------	--------------------------	----------	--

400	96-	MIDR 06.23.56B/41	RVI B9 B18	AKB-L2284				
-----	-----	----------------------	------------	-----------	--	--	--	--

400	00 -	MIDR 06.23.56B/41	ZF 16S-151 ZF 16S-181	AKB-L2713				
-----	------	----------------------	--------------------------	-----------	--	--	--	--

400	96 -	MIDR 06.23.56B/41	ZF 8S-151 ZF 16S-151 ZF 16S-181	AKB-L2895	430-701-L2882	430-019-L2885 2" x 10	CB-L2887	
-----	------	----------------------	---------------------------------------	-----------	---------------	--------------------------	----------	--

Premium Distribution

320.18	00 -	dCi11	ZF 12AS2301	AKB-L2713				
--------	------	-------	-------------	-----------	--	--	--	--

320.18	00 -	dCi11	ZF 9S-109	AKB-L2891	430-701-L2882	430-019-L2884 1 3/4" x 10	CB-L2889	
--------	------	-------	-----------	-----------	---------------	------------------------------	----------	--

320.26	00 -	dCi11	ZF 12AS2301	AKB-L2713				
--------	------	-------	-------------	-----------	--	--	--	--

320.26	00 -	dCi11	ZF 9S-109	AKB-L2891	430-701-L2882	430-019-L2884 1 3/4" x 10	CB-L2889	
--------	------	-------	-----------	-----------	---------------	------------------------------	----------	--

370.18	00 -	dCi11	ZF 16S-151	AKB-L2713				
--------	------	-------	------------	-----------	--	--	--	--

370.26	00 -	dCi11	ZF 16S-151	AKB-L2713				
--------	------	-------	------------	-----------	--	--	--	--

420.18	00 -	dCi11	ZF 12AS2301	AKB-L2713				
--------	------	-------	-------------	-----------	--	--	--	--

420.18	00 -	dCi11	ZF 8S-151 ZF 16S-151 ZF 16S-181 ZF 12AS2301	AKB-L2895	430-701-L2882	430-019-L2885 2" x 10	CB-L2887	
--------	------	-------	--	-----------	---------------	--------------------------	----------	--

Premium Route

320.18	00 -	dCi11	ZF 12AS2301	AKB-L2713				
--------	------	-------	-------------	-----------	--	--	--	--

320.18	00 -	dCi11		AKB-L2891	430-701-L2882	430-019-L2884 1 3/4" x 10	CB-L2889	
--------	------	-------	--	-----------	---------------	------------------------------	----------	--

370.18	00 -	dCi11	ZF 16S-151	AKB-L2713				
--------	------	-------	------------	-----------	--	--	--	--

370..26	00 -	dCi11	ZF 16S-151	AKB-L2713				
---------	------	-------	------------	-----------	--	--	--	--

420.18	00 -	dCi11	ZF 12AS2301	AKB-L2713				
--------	------	-------	-------------	-----------	--	--	--	--

420.24	00 -	dCi11	ZF 16S-151	AKB-L2713				
--------	------	-------	------------	-----------	--	--	--	--



Vehicle

Year



Engine



Gearbox



LIPE Kit No.



LIPE cover



LIPE Disc

LIPE
Bearing

Notes

RENAULT V.I Cont'd

420.25	00 -	dCi11	ZF 16S-151	AKB-L2713				
420.26	00 -	dCi11	ZF 16S-151	AKB-L2713				

SCANIA**93**

93	91-96	DN9 DS9 DSC9	GR900 GRS900	AKB-L2184	430-701-L2358	430-019-L2342 24 x 50	CB-L2481	
----	-------	--------------------	-----------------	-----------	---------------	--------------------------	----------	--

94

94	96- 09/04	DSC9	GR801 GR900 GRS900/R	AKB-L2017	430-701-L2361	430-019-L2342 24 x 50		
94	96- 09/04	DSC9	GR801 GR900 GRS900/R	AKB-L2014	430-701-L2361	430-019-L2342 24 x 50	CB-L1996	
94	03- 09/04	DSC9		AKB-L2903	430-701-L2341	430-019-L2342 24 x 50	CB-L3023	
94	03- 09/04	DSC9		AKB-L2903	430-701-L2341	430-019-L2342 24 x 50	CB-L3023	
94	03- 09/04	DSC9		AKB-L2903	430-701-L2341	430-019-L2342 24 x 50	CB-L3023	
94	03- 09/04	DSC9		AKB-L3264	430-701-L3595	430-019-L3572 24 x 50	CB-L3023	

113









113.360	91-96	DS11 DSC11 DTC11		AKB-L2184	430-701-L2358	430-019-L2342 24 x 50	CB-L2481	
113.400	91-96	DS11 DSC11 DTC11		AKB-L2184	430-701-L2358	430-019-L2342 24 x 50	CB-L2481	







114









114	96- 09/04	DSC11		AKB-L2017	430-701-L2361	430-019-L2342 24 x 50		
114	96- 09/04	DSC11	GR801 GR900 GRS900/R	AKB-L2014	430-701-L2361	430-019-L2342 24 x 50	CB-L1996	
114	03- 09/04	DC11	GR801 GR900 GRS900/R	AKB-L2903	430-701-L2341	430-019-L2342 24 x 50	CB-L3023	
114	03- 09/04	DC11	GR801 GR900 GRS900/R	AKB-L2903	430-701-L2341	430-019-L2342 24 x 50	CB-L3023	
114	03- 09/04	DC11	GR801 GR900 GRS900/R	AKB-L2903	430-701-L2341	430-019-L2342 24 x 50	CB-L3023	
114	03- 09/04	DC11		AKB-L3264	430-701-L3595	430-019-L3572 24 x 50	CB-L3023	









124

124	96-	DSC12	GR801 GR900 GRS900/R	AKB-L2017	430-701-L2361	430-019-L2342 24 x 50		
124	96-	DSC12		AKB-L2014	430-701-L2361	430-019-L2342 24 x 50	CB-L1996	
124	03-	DSC12	GR801 GR900 GRS900/R	AKB-L2903	430-701-L2341	430-019-L2342 24 x 50	CB-L3023	
124	03-	DSC12	GR801 GR900 GRS900/R	AKB-L2903	430-701-L2341	430-019-L2342 24 x 50	CB-L3023	
124	03-	DSC12	GR801 GR900 GRS900/R	AKB-L2903	430-701-L2341	430-019-L2342 24 x 50	CB-L3023	
124	03-	DSC12		AKB-L3264	430-701-L3595	430-019-L3572 24 x 50	CB-L3023	

 Vehicle	 Year	 Engine	 Gearbox	 LIPE Kit No.	 LIPE cover	 LIPE Disc	 LIPE Bearing	Notes
SCANIA Cont'd								
142								
142	Ch-88	DS14 DSC14	GR871 GR880	AKB-L2183				
143								
143	88-91	DSC14	GR880	AKB-L2183				
143	91-96	DSC14	GR900 GRS900	AKB-L2184	430-701-L2358	430-019-L2342 24 x 50	CB-L2481	
144								
144	96- 09/04	DSC14	GR801 GR900 GRS900/R	AKB-L2017	430-701-L2361	430-019-L2342 24 x 50		
144	96- 09/04	DSC14	GR801 GR900 GRS900/R	AKB-L2014	430-701-L2361	430-019-L2342 24 x 50	CB-L1996	
144	03-09/04	DSC14	GR801 GR900 GRS900/R	AKB-L2903	430-701-L2341	430-019-L2342 24 x 50	CB-L3023	
144	03-09/04	DSC14	GR801 GR900 GRS900/R	AKB-L2903	430-701-L2341	430-019-L2342 24 x 50	CB-L3023	
144	03-09/04	DSC14	GR801 GR900 GRS900/R	AKB-L2903	430-701-L2341	430-019-L2342 24 x 50	CB-L3023	
144	03-09/04	DSC14		AKB-L3264	430-701-L3595	430-019-L3572 24 x 50	CB-L3023	
164								
164	96- 09/04	DSC14	GR801 GR900 GRS900/R	AKB-L2017	430-701-L2361	430-019-L2342 24 x 50		
164	96- 09/04	DSC14	GR801 GR900 GRS900/R	AKB-L2014	430-701-L2361	430-019-L2342 24 x 50	CB-L1996	
164	03-	DC16	GR801 GR900 GRS900/R	AKB-L2903	430-701-L2341	430-019-L2342 24 x 50	CB-L3023	
164	03-	DC16	GR801 GR900 GRS900/R	AKB-L2903	430-701-L2341	430-019-L2342 24 x 50	CB-L3023	
164	03-	DC16	GR801 GR900 GRS900/R	AKB-L2903	430-701-L2341	430-019-L2342 24 x 50	CB-L3023	
164	03-	DC16		AKB-L3264	430-701-L3595	430-019-L3572 24 x 50	CB-L3023	
P Series								
	04-	DC9 DC11 DC12		AKB-L3264	430-701-L3595	430-019-L3572 24 x 50	CB-L3023	
	04-	DC9 DC11 DC12		AKB-L3264	430-701-L3595	430-019-L3572 24 x 50	CB-L3023	
	04-	DC9 DC11 DC12		AKB-L3264	430-701-L3595	430-019-L3572 24 x 50	CB-L3023	
	04-	DC9 DC11 DC12		AKB-L3264	430-701-L3595	430-019-L3572 24 x 50	CB-L3023	
	04-	DC9 DC11 DC12	GRS890 GRS900 GRS900R	AKB-L3264	430-701-L3595	430-019-L3572 24 x 50	CB-L3023	
	04-	DC9 DC11 DC12	GR801	AKB-L3264	430-701-L3595	430-019-L3572 24 x 50	CB-L3023	

 Vehicle	Year	 Engine	 Gearbox	 LIPE Kit No.	 LIPE cover	 LIPE Disc	 LIPE Bearing	Notes
SCANIA Cont'd								
R Series								
	04-	DC 11 DC12 DC16		AKB-L3264	430-701-L3595	430-019-L3572 24 x 50	CB-L3023	
	04-	DC 11 DC12 DC16		AKB-L3264	430-701-L3595	430-019-L3572 24 x 50	CB-L3023	
	04-	DC 11 DC12 DC16		AKB-L3264	430-701-L3595	430-019-L3572 24 x 50	CB-L3023	
	04-	DC 11 DC12 DC16		AKB-L3264	430-701-L3595	430-019-L3572 24 x 50	CB-L3023	
	04-	DC 11 DC12 DC16	GR801 GR900 GRS900/R	AKB-L3264	430-701-L3595	430-019-L3572 24 x 50	CB-L3023	
	04-	DC 11 DC12 DC16	GR801	AKB-L3264	430-701-L3595	430-019-L3572 24 x 50	CB-L3023	
SEDDON ATKINSON								
PENNINE 7		Gardner 6HLX		LP-1911-608				
301/311, 401/411"		Cummins 220		SP-L2374 LP-1138-607				
		Cummins L10-220		SP-L2352 LP-1911-688				
		Cummins 250		SP-L2374 LP-1138-607				
		Cummins L10-250		SP-L2352 LP-1911-688				
		Cummins E290		SP-L2374 LP-L1118-607				
		Cummins L10-290		SP-L2370 LP-1913-688				
		Cummins LTAA10-300		SP-2370 LP-1913-688				
		Cummins E320		LP-L0449-607				Adaptor Kit AK-L0802 may be required
		Cummins E350-21		LP-L0449-607				Adaptor Kit AK-L0802 may be required
		Cummins NTC335		LP-L0622-607				Adaptor Kit AK-L0802 may be required
		Gardner 6LXDT		SP-L2370 LP-1913-688				
		Gardner 6LXT		LP-L0449-607				Adaptor Kit AK-L0802 may be required
		Gardner 8LXB		SP-L2374 LP-1138-607				
		Gardner 8LXB		SP-L2352 LP-1911-688				
		Gardner 8LXCT		SP-L2352 LP-1911-688				
Strato		Cummins 6CTAA265		SP-L2371 LP-1138-608				
		Cummins LTAA10-300		SP-L2374 LP-1117-607				
		Cummins NTE320-21		LP-L0449-607				
		Cummins NTE320-21		SP-L0502 LP-L0449-608				Adaptor Kit AK-L0802 may be required
		Cummins LTA10-325		SP-L2355 LP-1139-608				

 Vehicle	 Year	 Engine	 Gearbox	 LIPE Kit No.	 LIPE cover	 LIPE Disc	 LIPE Bearing	Notes
SEDDON ATKINSON Cont'd								
		Cummins NTE350-21		LP-L0449-607				
		Cummins NTE350-21		SP-L0502 LP-L0449-608				Adaptor Kit AK-L0802 may be required
		Cummins NTE365-20		SP-L0502 LP-L0449-608				Adaptor Kit AK-L0802 may be required
		Cummins NTE400-21		LP-L0449-607				
		Cummins NTE400-21		SP-L0502 LP-L0449-608				Adaptor Kit AK-L0802 may be required
		Cummins L10-275		SP-L2371 LP-1138-608				
		Cummins NTAA-465		SP-L0502 LP-L0449-608				Adaptor Kit AK-L0802 may be required
		Cummins NTAA410		SP-L0502 LP-L0449-608				Adaptor Kit AK-L0802 may be required
		RR/Perkins 300LE		SP-L2374 LP-1117-607				
		RR/Perkins 300LE		SP-L2355 LP-1139-608				
6 X 4 MUNICIPAL		Cummins 240		SP-L2371 LP-1138-608				
211 SERIES		Cummins B210Series		AKB-L2267				Ceramic option AKB-L2685
17-325		Cummins B215/B235		AKB-L2267				
17-300C		Cummins C300-20		SP-L2371 LP-1138-608				
17-275C		Cummins C8-3-275-10		SP-L2371 LP-1138-608				
240C25		Cummins C8-3-240		LP-L0692-607				Ceramic Option LP-L0692-608
350-17		Cummins LT10-350		SP-L2355 LP-1117-608				
350-17		Cummins LT10-350		SP-L2355 LP-L0449-608				Adaptor Kit AK-L0802 may be required
350-17		Cummins LT10-350		LP-L0449-607				Adaptor Kit AK-L0802 may be required
17.305M		Cummins M305E20		AKB-L2534 AK-L1491				EATON RTSO 1231A Gearbox
17.340M		Cummins M340E20		AKB-L2534 AK-L1491				EATON RTSO 1231A Gearbox
17.380M		Cummins M380E20		AKB-L2534 AK-L1491				EATON RTSO 1231A Gearbox
17.405M		Cummins M405E20		AKB-L2534 AK-L1491				EATON RTSO 1231A Gearbox
17.305M		Cummins M305E20		SP-L2332 LP-L1868AK-688		2" x 10		EATON RTSO 1231A Gearbox
17.340M		Cummins M340E20		SP-L2332 LP-L1868AK-688		2" x 10		EATON RTSO 1231A Gearbox
17.380M		Cummins M380E20		SP-L2332 LP-L1868AK-688		2" x 10		EATON RTSO 1231A Gearbox
17.405M		Cummins M405E20		SP-L2332 LP-L1868AK-688		2" x 10		EATON RTSO 1231A Gearbox
17.425M		Cummins N425E20		AKB-L2534 AK-L1491				EATON RTSO 1231A Gearbox
17.475M		Cummins N475E20		AKB-L2534 AK-L1491				EATON RTSO 1231A Gearbox

 Vehicle	 Year	 Engine	 Gearbox	 LIPE Kit No.	 LIPE cover	 LIPE Disc	 LIPE Bearing	Notes
SEDDON ATKINSON Cont'd								
17.525M		Cummins N525E20		AKB-L2534 AK-L1491				EATON RTSO 1231A Gearbox
17.340M		Cummins N340		SP-L2332 LP-L1868AK-688		2" x 10		Solo Type SP-L2566 WITH ZF Gearbox Check clutch type from 01/99 solo type SP-L2566
17.380M		Cummins N380		SP-L2332 LP-L1868AK-688		2" x 10		Solo Type SP-L2566 WITH ZF Gearbox Check clutch type from 01/99 solo type SP-L2566
17.410M		Cummins N410		SP-L2332 LP-L1868AK-688		2" x 10		Solo Type SP-L2566 WITH ZF Gearbox Check clutch type from 01/99 solo type SP-L2566
17.500M		Cummins N500		SP-L2332 LP-L1868AK-688		2" x 10		Check clutch type from 01/99 solo type SP-L2566

Lipe clutch LP-L1868 AK-608 & AK-L688 should not be fitted with ZF Gearbox. Clutch cannot be adjusted! Fit SP-L kit only

Strato







96-		Eaton Sync		AKB-L2534	430-701-L2320	430-019-L2321 2" x 10 TM	CB-L1961	When fitted with Sachs as OE
-----	--	------------	--	-----------	---------------	-----------------------------	----------	---------------------------------









SISU FINLAND

SK355		Cummins L10-350		LP-1117-008				
SKM510		Cummins N14-500		LP-L0989-011				Adaptor kit AK-L614 may be required
SKM510		Cummins N14-525		LP-L1141-011		2" x 10		Adaptor kit AK-L614 may be required

TATA INDIA

1512 C	1996-	Cummins	GBS 40		330-061-L4001	330-009-L4000		
1518 C	2004-	Cummins	G 600		140-701-L1717	140-009-L2543		
1613 C	1996-	Cummins	GBS 40		330-061-L4001	330-009-L4000		
1613TC	1997-	697TC	GBS 40		330-061-L4001	330-009-L4000		
1615 C	2000-	Cummins	GBS 50		140-701-L2397	140-009-L2398		
1918 C	2007-	Cummins	G 600		140-701-L1717	140-009-L2543		
2515TCIC	2005-	697TCIC	G 600		140-701-L1717	140-009-L2543		
2516 C	1996-	Cummins 6BTA	G 600		140-701-L1717	140-009-L2543		
2516TCIC	2005-	697TCIC	G 600		140-701-L1717	140-009-L2543		
2518 C	2004-	Cummins 6BTA	G 600		140-701-L1717	140-009-L2543		
2518TCIC	2004-	697TCIC	G 600		140-701-L1717	140-009-L2543		
2523 C	2005-	Cummins 6BTA	Eaton FS10309		380-061-L2770	380-019L2771		
3015TC-EXTractor		Cummins 6BT		140-701-L1717, 140-009-L1731				
3118 C	2005-	Cummins 6BTA	G 600		140-701-L1717	140-009-L2543		
3516 C	2000-	Cummins 6BTA	G 600		140-701-L1717	140-009-L2543		
4018 C	1999-	Cummins 6BTA	G 600		140-701-L1717	140-009-L2543		
4923 C	2004-	Cummins 6BTA	Eaton FS10309		380-061-L2770	380-019L2771		
LPT 1112	2005-	497TC	GBS 40		310-701-L4483			
LPT 712	2004-	497TC	GBS 40		310-701-L4483			
LPT 713	1995-	697 NA	GBS 40		310-701-L4483			









 Vehicle	Year	 Engine	 Gearbox	 LIPE Kit No.	 LIPE cover	 LIPE Disc	 LIPE Bearing	Notes
TATA INDIA Cont'd								
LPK2516		Cummins 6BT		140-701-L1716, 140-009-L1732				
LPO1616		Cummins 6BTAA5.9		140-701-L1717, 140-009-L1731				
LPS1610		Cummins 6BTAA5.9		140-701-L1717, 140-009-L1731				
LPS4018		Cummins 6BT		140-701-L1717, 140-009-L1731				
LPT 1112	2005-	497TC	GBS 40			310-701-L4483		
LPT 712	2004-	497TC	GBS 40			310-701-L4483		
LPT 713	1995-	697 NA	GBS 40			310-701-L4483		
LPT1613Truck		Cummins 6BT		310-061-L1895, 130-009-L2021				
LPT1613Truck		Tata 697		310-061-L1895 130-009-L2021				
LPT2515TC		Tata 697		140-701-L1717, 140-009-L1731				
LPT2515TC		Cummins 6BT		140-701-L1717, 140-009-L1731				
LPT2516		Cummins 6BT		140-701-L1716, 140-009-L1732				
SE1613		Cummins 6BT		310-061-L1895, 130-009-L2021				
SK163		Cummins 6BT		310-061-L1895, 130-009-L2021				
SK163		Tata 697		310-061-L1895, 130-009-L2021				
VOLVO								
F6								
F6S	-85	TD60A, B	ZF S6-65 R1000	AKB-L1814				
F615	-85	TD60A, B	ZF S6-65 R1000	AKB-L1814				
F616	-85	TD60A, B	ZF S6-65 R1000	AKB-L1814				
F617	-85	TD60A, B	ZF S6-65 R1000	AKB-L1814				
FL6								
FL220	95-00	D6	Eaton V5206	AKB-L1814				
FL614	91-93	TD61F	ZF S6-65 ZF S6-66T700	AKB-L1814				
FL614	95-00	D6	Eaton V5206	AKB-L1814				
FL616	85-91	TD61F	ZF S6-65 ZF S6-66 R1000	AKB-L1814				
FL617	87-91	TD61	ZF S6-65 ZF S6-66 R1000	AKB-L1814				
FL618	91-95	TD61FTD63ES	ZF S6-65 R800 R1000T700	AKB-L1814				
FL618	95-00	D6-180	T600A	AKB-L1814				
FL618	96-00	D6-250	T700 R800	AKB-L1814				
FL618	95-00	D6	Eaton V5206	AKB-L1814				
FL626	97-00	D6	T700 R800	AKB-L1814				
FM7								
FM7	98-	D7C	R1400 SR1400	AKB-L2009	430-701-L2358	430-019-L2321 2" x 10	CB-L1986	
FM7	98-	D7C	VT2014 VT2514	AKB-L2416	430-701-L2358	430-019-L2321 2" x 10	CB-L2414	
FM9								
FM9 340	01-05	D9A	VT2009B	AKB-L2567	430-701-L2358	430-019-L2342 24 x 50	CB-L1986	
FM9 340	01-05	D9A	VT2214B VTO2214B	AKB-L2508	430-701-L2358	430-019-L2342 24 x 50	CB-L2414	
FM9 380	01-05	D9A	VT2009B	AKB-L2567	430-701-L2358	430-019-L2342 24 x 50	CB-L1986	

 Vehicle	 Year	 Engine	 Gearbox	 LIPE Kit No.	 LIPE cover	 LIPE Disc	 LIPE Bearing	Notes
VOLVO Cont'd								
FM9 380	01-05	D9A	VT2214B VTO2214B	AKB-L2508	430-701-L2358	430-019-L2342 24 x 50	CB-L2414	
F10								
F10	83-94	TD102FL	R1000 R1400 SR1400 R1700 SR1700	AKB-L2009	430-701-L2358	430-019-L2321 2" x 10	CB-L1986	
F10	83-94	TD102FL	R1000 R1400 SR1400 R1700 SR1700	AKB-L2009	430-701-L2358	430-019-L2321 2" x 10	CB-L1986	
FL10								
FL10	85-99	TD101 TD102 TD103	R,SR1400 R,SR1700	AKB-L2009	430-701-L2358	430-019-L2321 2" x 10	CB-L1986	
FL10	85-99	TD101 TD102 TD103	R,SR1400 R,SR1700	AKB-L2009	430-701-L2358	430-019-L2321 2" x 10	CB-L1986	
FL10	85-99	D10A	SR1400	AKB-L2009	430-701-L2358	430-019-L2321 2" x 10	CB-L1986	
FM10								
FM10	98-	D10B	R,SR1400 SR1700	AKB-L2009	430-701-L2358	430-019-L2321 2" x 10	CB-L1986	
FM10	98-	D10B	VT2014 VT2514	AKB-L2416	430-701-L2358	430-019-L2321 2" x 10	CB-L2414	
F12								
F12	83-94	TD122 TD123	R1700 SR1700	AKB-L2009	430-701-L2358	430-019-L2321 2" x 10	CB-L1986	
FH12								
FH12	93-	D12A	R,SR1700 SR1900	AKB-L2009	430-701-L2358	430-019-L2321 2" x 10	CB-L1986	
FH12 340		D12A	R,SR1700 SR1900	AKB-L2108				
FH12 340	93-	D12A	R,SR1700 SR1900	AKB-L2108				
FH12 340	93-	D12A	R,SR1700 SR1900	AKB-L2108				
FH12 340	98-	D12C	R,SR1700 SR1900	AKB-L2009	430-701-L2358	430-019-L2321 2" x 10	CB-L1986	
FH12 340	98-	D12C	R,SR1700 SR1900	AKB-L2108				
FH12 340	98-	D12C	R,SR1700 SR1900	AKB-L2108				
FH12 340	98-	D12C	VT2014 VT2014OD	AKB-L2416	430-701-L2358	430-019-L2321 2" x 10	CB-L2414	
FH12 380	93-	D12A	R,SR1700 SR1900	AKB-L2009	430-701-L2358	430-019-L2321 2" x 10	CB-L1986	
FH12 380	93-	D12A	R,SR1700 SR1900	AKB-L2108				
FH12 380	93-	D12A	R,SR1700 SR1900	AKB-L2108				
FH12 380	98-	D12C	R,SR1700 SR1900	AKB-L2009	430-701-L2358	430-019-L2321 2" x 10	CB-L1986	
FH12 380	98-	D12C	R,SR1700 SR1900	AKB-L2108				
FH12 380	98-	D12C	R,SR1700 SR1900	AKB-L2108				
FH12 380	98-	D12C	VT2014 VT2014OD	AKB-L2416	430-701-L2358	430-019-L2321 2" x 10	CB-L2414	
FH12 380	98-	D12C	VT2514	AKB-L3618	430-701-L2358	430-019-L3617 2" x 10	CB-L2414	disc fitted with pre damp to fw side
FH12 380	98-	D12C	VT2514 VTO2514	AKB-L2109			CB-L2693	

 Vehicle	 Year	 Engine	 Gearbox	 LIPE Kit No.	 LIPE cover	 LIPE Disc	 LIPE Bearing	Notes
VOLVO Cont'd								
FH12 380	98-	D12C	VT2514 VTO2514	AKB-L2109			CB-L2693	
FH12 380	01-	D12D	VT2009B	AKB-L2567	430-701-L2358	430-019-L2342 24 x 50	CB-L1986	
FH12 380	01-	D12D	VT2009B	AKB-L2574				
FH12 380	01-	D12D	VT2214B VTO2214B	AKB-L2508	430-701-L2358	430-019-L2342 24 x 50	CB-L2414	
FH12 380	01-	D12D	VT2214B VTO2214B	AKB-L2856			CB-L2693	
FH12 380	01-	D12D	VT2214B VTO2214B	AKB-L2856			CB-L2693	
FH12 380	01-	D12D	VT2412B	AKB-L2928	430-701-L2358	430-019-L3126 24 x 50	CB-L2693	
FH12 420	93-	D12A	R,SR1700 SR1900	AKB-L2009	430-701-L2358	430-019-L2321 2" x 10	CB-L1986	
FH12 420	93-	D12A	R,SR1700 SR1900	AKB-L2108				
FH12 420	93-	D12A	R,SR1700 SR1900	AKB-L2108				
FH12 420	98-	D12C	R,SR1700 SR1900	AKB-L2009	430-701-L2358	430-019-L2321 2" x 10	CB-L1986	
FH12 420	98-	D12C	R,SR1700 SR1900	AKB-L2108				
FH12 420	98-	D12C	R,SR1700 SR1900	AKB-L2108				
FH12 420	98-	D12C	VT2014 VT2014OD	AKB-L2416	430-701-L2358	430-019-L2321 2" x 10	CB-L2414	Cover with release bearing Clutch type CL43S-O
FH12 420	98-	D12C	VT2014 VT2014OD	AKB-L2109			CB-L2693	
FH12 420	98-	D12C	VT2014 VT2014OD	AKB-L2109			CB-L2693	
FH12 420	01-	D12D	VT2009B	AKB-L2567	430-701-L2358	430-019-L2342 24 x 50	CB-L1986	
FH12 420	01-	D12D	VT2009B	AKB-L2574				
FH12 420	01-	D12D	VT2214B VTO2214B	AKB-L2508	430-701-L2358	430-019-L2342 24 x 50	CB-L2414	
FH12 420	01-	D12D	VT2214B VTO2214B	AKB-L2856			CB-L2693	
FH12 420	01-	D12D	VT2214B VTO2214B	AKB-L2856			CB-L2693	
FH12 420	01-	D12D	VT2142B	AKB-L2928	430-701-L2358	430-019-L3126 24 x 50	CB-L2693	
FH12 460	98-	D12C	VT2014 VT2014OD	AKB-L2416	430-701-L2358	430-019-L2321 2" x 10	CB-L2414	
FH12 460	98-	D12C	VT2514	AKB-L3618	430-701-L2358	430-019-L3617 2" x 10	CB-L2414	disc fitted with pre damp to fw side
FH12 460	98-	D12C	VT2514 VTO2514	AKB-L2109			CB-L2693	
FH12 460	98-	D12C	VT2514 VTO2514	AKB-L2109			CB-L2693	
FH12 460	98-	D12C	VT2014 VT2014OD	AKB-L2416	430-701-L2358	430-019-L2321 2" x 10	CB-L2414	
FH12 460	01-	D12D	VT2412B	AKB-L3597	430-701-L3592	430-019-L3573 24 x 50	CB-L2693	
FH12 460	01-	D12D	VT2514 VTO2514	AKB-L3263	430-701-L3592	430-019-L3573 24 x 50	CB-L2414	
FH12 460	01-	D12D	VT2514 VTO2514	AKB-L2856			CB-L2693	
FH12 460	01-	D12D	VT2514 VTO2514	AKB-L2856			CB-L2693	
FH12 500	01-	D12D	VT2412B	AKB-L3597	430-701-L3592	430-019-L3573 24 x 50	CB-L2693	
FH12 500	01-	D12D	VT2412B	AKB-L3263	430-701-L3592	430-019-L3573 24 x 50	CB-L2414	

 Vehicle	Year	 Engine	 Gearbox	 LIPE Kit No.	 LIPE cover	 LIPE Disc	 LIPE Bearing	Notes
VOLVO Cont'd								
FH12 500	01-	D12D	VT2514 VTO2514	AKB-L2856			CB-L2693	
FH12 500	01-	D12D	VT2514 VTO2514	AKB-L2856			CB-L2693	
FH 2005 -								
FH 400	09/05-	D13A/B400	VT2009B	AKB-L3597	430-701-L3592	430-019-L3573 24 x 50	CB-L2693	
FH 400	09/05-	D13A/B400	VT2009B	AKB-L3263	430-701-L3592	430-019-L3573 24 x 50	CB-L2414	
FH 400	09/05-	D13A/B400	VT2009B	AKB-L2574				
FH 400	09/05-	D13A/B400	VT,VTO2214B VT,VTO2514B	AKB-L3263	430-701-L3592	430-019-L3573 24 x 50	CB-L2414	
FH 400	09/05-	D13A/B400		AKB-L2856			CB-L2693	
FH 440	09/05-	D13A/B440	VT,VTO2214B VT,VTO2514B	AKB-L3263	430-701-L3592	430-019-L3573 24 x 50	CB-L2414	
FH440	09/05-	D13A/B440	VT2009B	AKB-L2574				
FH 440	09/05-	D13A/B440		AKB-L2856			CB-L2693	
FH 480	09/05-	D13A480	VT,VTO2214B VT,VTO2514B	AKB-L3263	430-701-L3592	430-019-L3573 24 x 50	CB-L2414	
FH 480	09/05-	D13A480	VT2009B	AKB-L2574				
FH 480	09/05-	D13A480		AKB-L2856			CB-L2693	
FH 520	09/05-	D13A520	VT,VTO2214B VT,VTO2514B	AKB-L3263	430-701-L3592	430-019-L3573 24 x 50	CB-L2414	
FH 520	09/05-	D13A520	VT2009B	AKB-L2574				
FH 520	09/05-	D13A520		AKB-L2856			CB-L2693	
FL12								
FL12	95-99	D12A	R,SR1700 SR1900	AKB-L2009	430-701-L2358	430-019-L2321 2" x 10	CB-L1986	
FL12	95-99	D12A	R,SR1700 SR1900	AKB-L2108				
FL12	95-99	D12A	R,SR1700 SR1900	AKB-L2108				
FM12								
FM12 340	98-	D12C	R,SR1700 SR1900	AKB-L2009	430-701-L2358	430-019-L2321 2" x 10	CB-L1986	
FM12 340	98-	D12C	R,SR1700 SR1900	AKB-L2108				
FM12 340	98-	D12C	R,SR1700 SR1900	AKB-L2108				
FM12 340	98-	D12C	VT2014 VT2014OD	AKB-L2416	430-701-L2358	430-019-L2321 2" x 10	CB-L2414	
FM12 340	98-	D12C	VT2514	AKB-L3618	430-701-L2358	430-019-L3617 2" x 10	CB-L2414	
FM12 340	98-	D12C	VT2514 VTO2514	AKB-L2109			CB-L2693	
FM12 340	98-	D12C	VT2514 VTO2514	AKB-L2109			CB-L2693	
FM12 340	01-	D12D	VT2009B	AKB-L2567	430-701-L2358	430-019-L2342 24 x 50	CB-L1986	
FM12 340	01-	D12D	VT2009B	AKB-L2574				
FM12 340	01-	D12D	VT2214B VTO2214B	AKB-L2508	430-701-L2358	430-019-L2342 24 x 50	CB-L2414	
FM12 340	01-	D12D	VT2214B VTO2214B	AKB-L2856			CB-L2693	
FM12 340	01-	D12D	VT2214B VTO2214B	AKB-L2856			CB-L2693	
FM12 340	01-	D12D	VT2412B	AKB-L2928	430-701-L2358	430-019-L3126 24 x 50	CB-L2693	
FM12 380	98-	D12C	R,SR1700 SR1900	AKB-L2009	430-701-L2358	430-019-L2321 2" x 10	CB-L1986	
FM12 380	98-	D12C	R,SR1700 SR1900	AKB-L2108				

 Vehicle	 Year	 Engine	 Gearbox	 LIPE Kit No.	 LIPE cover	 LIPE Disc	 LIPE Bearing	Notes
VOLVO Cont'd								
FM12 380	98-	D12C	R,SR1700 SR1900	AKB-L2108				
FM12 380	98-	D12C	VT2014 VT2014OD	AKB-L2416	430-701-L2358	430-019-L2321 2" x 10	CB-L2414	
FM12 380	98-	D12C	VT2514	AKB-L3618	430-701-L2358	430-019-L3617 2" x 10	CB-L2414	
FM12 380	98-	D12C	VT2514 VTO2514	AKB-L2109			CB-L2693	
FM12 380	98-	D12C	VT2514 VTO2514	AKB-L2109			CB-L2693	
FM12 380	01-	D12D	VT2009B	AKB-L2567	430-701-L2358	430-019-L2342 24 x 50	CB-L1986	
FM12 380	01-	D12D	VT2009B	AKB-L2574				
FM12 380	01-	D12D	VT2214B VTO2214B	AKB-L2508	430-701-L2358	430-019-L2342 24 x 50	CB-L2414	
FM12 380	01-	D12D	VT2214B VTO2214B	AKB-L2856			CB-L2693	
FM12 380	01-	D12D	VT2214B VTO2214B	AKB-L2856			CB-L2693	
FM12 380	01-	D12D	VT2412B	AKB-L2928	430-701-L2358	430-019-L3126 24 x 50	CB-L2693	
FM12 420	98-	D12C	R,SR1700 SR1900	AKB-L2009	430-701-L2358	430-019-L2321 2" x 10	CB-L1986	
FM12 420	98-	D12C	R,SR1700 SR1900	AKB-L2108				
FM12 420	98-	D12C	R,SR1700 SR1900	AKB-L2108				
FM12 420	98-	D12C	VT2014 VT2014OD	AKB-L2416	430-701-L2358	430-019-L2321 2" x 10	CB-L2414	
FM12 420	98-	D12C	VT2514 VTO2514	AKB-L2109			CB-L2693	
FM12 420	98-	D12C	VT2514 VTO2514	AKB-L2109			CB-L2693	
FM12 420	01-	D12D	VT2009B	AKB-L2567	430-701-L2358	430-019-L2342 24 x 50	CB-L1986	
FM12 420	01-	D12D	VT2009B	AKB-L2574				
FM12 420	01-	D12D	VT2214B VTO2214B	AKB-L2508	430-701-L2358	430-019-L2342 24 x 50	CB-L2414	
FM12 420	01-	D12D	VT2214B VTO2214B	AKB-L2856			CB-L2693	
FM12 420	01-	D12D	VT2214B VTO2214B	AKB-L2856			CB-L2693	
FM12 420	01-	D12D	VT2412B	AKB-L2928	430-701-L2358	430-019-L3126 24 x 50	CB-L2693	
FM12 460	98-	D12C	R,SR1700 SR1900	AKB-L2009	430-701-L2358	430-019-L2321 2" x 10	CB-L1986	
FM12 460	98-	D12C	R,SR1700 SR1900	AKB-L2108				
FM12 460	98-	D12C	R,SR1700 SR1900	AKB-L2108				
FM12 460	98-	D12C	VT2014 VT2014OD	AKB-L2416	430-701-L2358	430-019-L2321 2" x 10	CB-L2414	
FM12 380	98-	D12C	VT2514	AKB-L3618	430-701-L2358	430-019-L3617 2" x 10	CB-L2414	
FM12 460	98-	D12C	VT2514 VTO2514	AKB-L2109			CB-L2693	
FM12 460	98-	D12C	VT2514 VTO2514	AKB-L2109			CB-L2693	
FM12 460	01-	D12D	VT2009B	AKB-L2567	430-701-L2358	430-019-L2342 24 x 50	CB-L1986	
FM12 460	01-	D12D	VT2009B	AKB-L2574				
FM12 460	01-	D12D	VT2214B VTO2214B	AKB-L2508	430-701-L2358	430-019-L2342 24 x 50	CB-L2414	
FM12 460	01-	D12D	VT2214B VTO2214B	AKB-L2856			CB-L2693	

 Vehicle	 Year	 Engine	 Gearbox	 LIPE Kit No.	 LIPE cover	 LIPE Disc	 LIPE Bearing	Notes
VOLVO Cont'd								
FM12 460	01-	D12D	VT2214B VTO2214B	AKB-L2856			CB-L2693	
FM12 460	01-	D12D	VT2412B	AKB-L3597	430-701-L3592	430-019-L3573 24 x 50	CB-L2693	
FM12 460	01-	D12D	VT2514 VTO2514	AKB-L3263	430-701-L3592	430-019-L3573 24 x 50	CB-L2414	
FM12 460	01-	D12D	VT2514 VTO2514	AKB-L2856			CB-L2693	
FM12 460	01-	D12D	VT2514 VTO2514	AKB-L2856			CB-L2693	
FM12 460	01-	D12D	VT2412B	AKB-L2928	430-701-L2358	430-019-L3126 24 x 50	CB-L2693	
FM 2005 -								
FM 300	09/05 -	D9B300	VT2009B	AKB-L2567	430-701-L2358	430-019-L3617 2" x 10	CB-L1986	
FM 340	09/05 -	D9B340	VT2009B	AKB-L2567	430-701-L2358	430-019-L2342 24 x 50	CB-L1986	
FM 340	09/05 -	D9B340	VT,VTO2214B VT,VTO2514B	AKB-L2508	430-701-L2358	430-019-L2342 24 x 50	CB-L2414	
FM 360	09/05 -	D13A/B360	VT2009B	AKB-L3597	430-701-L3592	430-019-L3573 24 x 50	CB-L2693	
FM 360	09/05 -	D13A/B360	VT2009B	AKB-L3263	430-701-L3592	430-019-L3573 24 x 50	CB-L2414	
FM 360	09/05 -	D13A/B360	VT2009B	AKB-L2574				
FM 360	09/05 -	D13A/B360		AKB-L2856			CB-L2693	
FM 380	09/05 -	D9B380	VT2009B	AKB-L2567	430-701-L2358	430-019-L2342 24 x 50	CB-L1986	
FM 380	09/05 -	D9B380	VT,VTO2214B VT,VTO2514B	AKB-L2508	430-701-L2358	430-019-L2342 24 x 50	CB-L2414	
FM 400	09/05-	D13A/B400	VT2009B	AKB-L3597	430-701-L3592	430-019-L3573 24 x 50	CB-L2693	
FM 400	09/05-	D13A/B400	VT2009B	AKB-L3263	430-701-L3592	430-019-L3573 24 x 50	CB-L2414	
FM 400	09/05-	D13A/B400	VT2009B	AKB-L2574				
FM 400	09/05-	D13A/B400	VT,VTO2214B VT,VTO2514B	AKB-L3263	430-701-L3592	430-019-L3573 24 x 50	CB-L2414	
FM 400	09/05-	D13A/B400		AKB-L2856			CB-L2693	
FM 440	09/05-	D13A/B440	VT,VTO2214B VT,VTO2514B	AKB-L3263	430-701-L3592	430-019-L3573 24 x 50	CB-L2414	
FM440	09/05-	D13A/B440	VT2009B	AKB-L2574				
FM 440	09/05-	D13A/B440		AKB-L2856			CB-L2693	
FM 480	09/05-	D13A480	VT,VTO2214B VT,VTO2514B	AKB-L3263	430-701-L3592	430-019-L3573 24 x 50	CB-L2414	
FM 480	09/05-	D13A480	VT2009B	AKB-L2574				
FM 480	09/05-	D13A480		AKB-L2856			CB-L2693	
FM 520	09/05-	D13A520	VT,VTO2214B VT,VTO2514B	AKB-L3263	430-701-L3592	430-019-L3573 24 x 50	CB-L2414	
FM 520	09/05-	D13A520	VT2009B	AKB-L2574				
FM 520	09/05-	D13A520		AKB-L2856			CB-L2693	
FH16								
FH16	98-	D16B	VT2814 VTO2814	AKB-L2109			CB-L2693	
FH16	98-	D16B	VT2814 VTO2814	AKB-L2109			CB-L2693	
FH16	03-	D16C	VT2814 VTO2814	AKB-L2109			CB-L2693	
FH16	03-	D16C	VT2814 VTO2814	AKB-L2109			CB-L2693	
FH16	03-	D16C	VT2514 VTO2514	AKB-L2856			CB-L2693	
FH16	03-	D16C	VT2514 VTO2514	AKB-L2856			CB-L2693	



Vehicle

Year



Engine



Gearbox



LIPE Kit No.



LIPE cover



LIPE Disc

LIPE
Bearing

Notes

ASHOK LEYLAND BUS

12 M Bus 380-019-L4036

DENNIS**JAVELIN**

					430-701-L2320	430-019-L3551 2" x 10	
10M, 12M	02-	Cummins Euro 3 275HP	ZF S6-85		395-071-L3098	395-019-L3100 1 3/4" x 10	

R Series

R345 R420		Cummins ISMe Euro 3	ZF AS Tronic AS2300		430-701-L2320	430-019-L2321 2" x 10	CB-L1339
-----------	--	------------------------	------------------------	--	---------------	--------------------------	----------

EVOBUS

S250		OM402LA OM442A, LA			430-701-L2320		
S250		MAN			430-701-L2320		
S312HD, HDH		OM402LA OM442A, LA			430-701-L2320		
S315HD, HDH		OM402LA OM442A, LA			430-701-L2320		
S316HDS		OM422LA			430-701-L2320		
S317HDH		OM422LA			430-701-L2320		

MAN

18.310	92-	D2866LOH	ZF S6-85		430-701-L2320		CB-L1961
18.370 A51 Chassis	92-	D2866LOH	ZF S6-1600		430-701-L2320		CB-L1962
18.370 A55 Chassis	95-	D2866LOH	ZF S6-180		430-701-L2320		CB-L1963

MERCEDES**Vario**

614D Vario Mini Bus	96-	OM904LA	ZF	AKB-L2283	362-071-L3143	362-019-L3134 18 x 40	CB-L3416
810 Vario Mini Bus	96-	OM904LA	ZF	AKB-L2283	362-071-L3143	362-019-L3134 18 x 40	CB-L3416

NEOPLAN**Man Engines**







		D2866LOH D2876LOH			430-701-L2320	430-019-L2321 2" x 10	
--	--	----------------------	--	--	---------------	--------------------------	--

Mercedes Engines

380HP		OM402LA OM442LA			430-701-L2320	430-019-L2321 2" x 10	
-------	--	--------------------	--	--	---------------	--------------------------	--

SCANIA**K94**

94	96-	DSC9	GR801	AKB-L2853	430-701-L2360	430-019-L1399 24 x 50	
94	96-	DSC9	GR801	AKB-L2014	430-701-L2361	430-019-L2342 24 x 50	CB-L1996
94	01-94 -	DSC9	GR801 GR900 GRS900/R	AKB-L2903	430-701-L2341	430-019-L2342 24 x 50	CB-L3023

 Vehicle	Year	 Engine	 Gearbox	 LIPE Kit No.	 LIPE cover	 LIPE Disc	 LIPE Bearing	Notes
K114								
114	01-94 -			AKB-L2853	430-701-L2360	430-019-L1399 24 x 50		
114	01-94 -			AKB-L2014	430-701-L2361	430-019-L2342 24 x 50	CB-L1996	
114	01-94 -			AKB-L2903	430-701-L2341	430-019-L2342 24 x 50	CB-L3023	
K124								
124	01-94 -			AKB-L2853	430-701-L2360	430-019-L1399 24 x 50		
124	01-94 -			AKB-L2014	430-701-L2361	430-019-L2342 24 x 50	CB-L1996	
124	01-94 -			AKB-L2903	430-701-L2341	430-019-L2342 24 x 50	CB-L3023	
TATA BUSES								
LPO 1610 RE		Cummins	G600		140-701-L1717	140-009-L2543		
LP 1510		Cummins	GBS 40		330-061-L4001	330-009-L4000		
LP 1610		Cummins	G600		140-701-L1717	140-009-L2543		
SFC 713		697TC	GBS 40		310-701-L4483			
LP 916		Cummins	G600		140-701-L1717	140-009-L2543		
LP 918		Cummins	G600		140-701-L1717	140-009-L2543		
LPO 1616		Cummins	G600		140-701-L1717	140-009-L2543		
LPO 1623 RE		Cummins	G600		140-701-L1717	140-009-L2543		
LP 1510			GBS 40		330-061-L4001	330-009-L4000		
LP/LPO 1613		697 TCIC	GBS 40		330-061-L4001	330-009-L4000		
LPO 1316		Cummins	GBS 50		140-701-L2397	140-009-L2398		
LPO 1318		Cummins	G600		140-701-L1717	140-009-L2543		
LPO 1618		Cummins	G600		140-701-L1717	140-009-L2543		
LPO 1623		Cummins	G600		380-061-L2770	380-019L2771		
VOLVO								
B10								
B10B		THD101GC THD101GD THD102KB THD102KD	G7-EGS	AKB-L2009	430-701-L2358	430-019-L2321 2" x 10	CB-L1986	
B10M		THD101G THD102KA THD102KB	G7-EGS	AKB-L2010	430-701-L2358	430-019-L2321 2" x 10	CB-L1986	
B10M		THD101G THD102KA THD102KB	G7-EGS	AKB-L2011	430-701-L2358	430-019-L2321 2" x 10	CB-L1986	
B10M		THD102KA THD102KB THD102KD THD102KE	G7-EGS	AKB-L2012	430-701-L2358	430-019-L2321 2" x 10	CB-L1986	
B12								
B12	91-	THD122FH THD122FL	G7-EGS	AKB-L2009	430-701-L2358	430-019-L2321 2" x 10	CB-L1986	
B12		TD123	G8	AKB-L2009	430-701-L2358	430-019-L2321 2" x 10	CB-L1986	
B12B		D12A	G8-EGS	AKB-L2009	430-701-L2358	430-019-L2321 2" x 10	CB-L1986	

LIPE/Valeo Cross Reference

LIPE REF	Valeo Ref	LIPE REF	Valeo Ref	Valeo Ref	LIPE REF	Valeo Ref	LIPE REF
AKB-L1827	805117	AKB-L2204	827026	805028	AKB-L2004	809125	AKB-L2511
AKB-L1806	805466	AKB-L2205	805167	805028	AKB-L2105	809126	AKB-L3173
AKB-L1808	805039	AKB-L2208	805298	805029	AKB-L2005	809128	AKB-L2011
AKB-L1808	805049	AKB-L2277	805301	805029	AKB-L2176	809131	AKB-L2011
AKB-L1818	827035	AKB-L2279	827012	805034	AKB-L2169	809133	AKB-L2627
AKB-L1822	827145	AKB-L2279	827012	805035	AKB-L2078	809134	AKB-L2011
AKB-L1825	827021	AKB-L2284	809047	805036	AKB-L1826	809136	AKB-L2456
AKB-L1826	805036	AKB-L2285	805060	805036	AKB-L1826	809136	AKB-L2627
AKB-L1826	805036	AKB-L2416	809109	805037	AKB-L3173	809140	AKB-L2204
AKB-L1828	805143	AKB-L2416	809113	805038	AKB-L2006	809142	AKB-L2893
AKB-L1829	805161	AKB-L2456	809136	805039	AKB-L1808	827004	AKB-L2074
AKB-L2004	805028	AKB-L2508	827088	805049	AKB-L1808	827005	AKB-L2073
AKB-L2005	805029	AKB-L2511	809125	805060	AKB-L2285	827011	AKB-L2917
AKB-L2006	805038	AKB-L2567	827070	805062	AKB-L2007	827012	AKB-L2279
AKB-L2007	805062	AKB-L2627	809133	805063	AKB-L2011	827012	AKB-L2279
AKB-L2008	805164	AKB-L2627	809136	805073	AKB-L2184	827016	AKB-L2076
AKB-L2009	805140	AKB-L2713	809115	805087	AKB-L2183	827021	AKB-L1825
AKB-L2009	809108	AKB-L2891	805193	805117	AKB-L1827	827026	AKB-L2204
AKB-L2011	805063	AKB-L2891	805341	805140	AKB-L2009	827029	AKB-L2107
AKB-L2011	805457	AKB-L2893	809142	805143	AKB-L1828	827031	AKB-L2109
AKB-L2011	809128	AKB-L2894	805386	805161	AKB-L1829	827031	AKB-L2109
AKB-L2011	809131	AKB-L2895	805358	805163	AKB-L2174	827033	AKB-L2014
AKB-L2011	809134	AKB-L2903	827053	805163	AKB-L2178	827035	AKB-L1818
AKB-L2012	805457	AKB-L2917	827011	805164	AKB-L2008	827053	AKB-L2903
AKB-L2014	827033	AKB-L2928	827223	805167	AKB-L2204	827055	AKB-L3264
AKB-L2073	827005	AKB-L2969	805245	805167	AKB-L2205	827070	AKB-L2567
AKB-L2074	827004	AKB-L2983	805297	805193	AKB-L2891	827088	AKB-L2508
AKB-L2076	827016	AKB-L3173	805037	805245	AKB-L2969	827096	AKB-L3263
AKB-L2078	805035	AKB-L3173	809126	805258	AKB-L2162	827145	AKB-L1822
AKB-L2080	809117	AKB-L3263	827096	805258	AKB-L2162	827223	AKB-L2928
AKB-L2084	809119	AKB-L3264	827055	805258	AKB-L2162	827527	AKB-L2084
AKB-L2084	827527			805291	AKB-L2204		
AKB-L2105	805028			805297	AKB-L2983		
AKB-L2107	827029			805298	AKB-L2208		
AKB-L2109	827031			805301	AKB-L2277		
AKB-L2109	827031			805341	AKB-L2891		
AKB-L2162	805258			805358	AKB-L2895		
AKB-L2162	805258			805386	AKB-L2894		
AKB-L2162	805258			805453	AKB-L2184		
AKB-L2169	805034			805457	AKB-L2011		
AKB-L2174	805163			805457	AKB-L2012		
AKB-L2176	805029			805466	AKB-L1806		
AKB-L2178	805163			809047	AKB-L2284		
AKB-L2183	805087			809108	AKB-L2009		
AKB-L2184	805073			809109	AKB-L2416		
AKB-L2184	805453			809113	AKB-L2416		
AKB-L2204	805167			809115	AKB-L2713		
AKB-L2204	805291			809117	AKB-L2080		
AKB-L2204	809140			809119	AKB-L2084		

LIPE/LUK Cross Reference

LIPE	LUK	LIPE	LUK	LIPE	LUK	LIPE	LUK
AKB-L1806	640295150	AKB-L2138	642291600	628287400	AKB-L2071	640301409	AKB-L2983
AKB-L1808	640274650	AKB-L2162	643291200	628300200	AKB-L2068	640301419	AKB-L2277
AKB-L1808	640301650	AKB-L2162	643302400	628300600	AKB-L2071	640301650	AKB-L1808
AKB-L1814	638290600	AKB-L2162	643305000	631101800	AKB-L1826	640302000	AKB-L2000
AKB-L1817	633300300	AKB-L2169	643301500	631287300	AKB-L2061	640302518	AKB-L2109
AKB-L1818	643318300	AKB-L2174	643292100	631289800	AKB-L2072	640302718	AKB-L2856
AKB-L1822	635291500	AKB-L2176	643293900	631300200	AKB-L2790	640303000	AKB-L2915
AKB-L1823	633290300	AKB-L2178	643302000	631300300	AKB-L2067	640303100	AKB-L2918
AKB-L1825	635289000	AKB-L2183	643309600	633101900	AKB-L3173	640303200	AKB-L2506
AKB-L1825	635302000	AKB-L2184	643310700	633290300	AKB-L1823	640303300	AKB-L2506
AKB-L1826	631101800	AKB-L2204	643303800	633294900	AKB-L2050	640303800	AKB-L2713
AKB-L1827	640295000	AKB-L2204	643309000	633300200	AKB-L2295	640303900	AKB-L2979
AKB-L1828	640297800	AKB-L2204	643321600	633300300	AKB-L1817	640304000	AKB-L2915
AKB-L1829	640292900	AKB-L2204	643325809	633300609	AKB-L2079	641295300	AKB-L2080
AKB-L2000	640302000	AKB-L2205	643303600	633306700	AKB-L3173	641300100	AKB-L2015
AKB-L2001	640300100	AKB-L2208	643301400	635287600	AKB-L2074	642291600	AKB-L2138
AKB-L2004	643289700	AKB-L2266	638305300	635289000	AKB-L1825	642305400	AKB-L2121
AKB-L2005	643320400	AKB-L2273	635306400	635290800	AKB-L2073	642306700	AKB-L2115
AKB-L2006	643308500	AKB-L2277	640301419	635290900	AKB-L2076	643274400	AKB-L2012
AKB-L2007	643301300	AKB-L2279	636300300	635291500	AKB-L1822	643289700	AKB-L2004
AKB-L2008	643308800	AKB-L2284	640301218	635299099	AKB-L2941	643291200	AKB-L2162
AKB-L2008	643325400	AKB-L2285	635304100	635300500	AKB-L3000	643291700	AKB-L2105
AKB-L2009	643298100	AKB-L2295	633300200	635301100	AKB-L2908	643292100	AKB-L2174
AKB-L2009	643318400	AKB-L2416	643320100	635302000	AKB-L1825	643293900	AKB-L2176
AKB-L2011	643300900	AKB-L2456	643326200	635304100	AKB-L2285	643298100	AKB-L2009
AKB-L2011	643321100	AKB-L2505	636301100	635304300	AKB-L2059	643300900	AKB-L2011
AKB-L2011	643323000	AKB-L2506	640303200	635306200	AKB-L2904	643301300	AKB-L2007
AKB-L2012	643274400	AKB-L2506	640303300	635306400	AKB-L2273	643301400	AKB-L2208
AKB-L2014	643325900	AKB-L2508	643320900	635306500	AKB-L2082	643301500	AKB-L2169
AKB-L2015	641300100	AKB-L2511	635351400	635306600	AKB-L2912	643302000	AKB-L2178
AKB-L2018	636300209	AKB-L2567	643321400	635351400	AKB-L2511	643302400	AKB-L2162
AKB-L2050	633294900	AKB-L2574	638309000	636300209	AKB-L2018	643303600	AKB-L2205
AKB-L2059	635304300	AKB-L2627	643320300	636300300	AKB-L2279	643303800	AKB-L2204
AKB-L2061	631287300	AKB-L2627	643320700	636301100	AKB-L2505	643305000	AKB-L2162
AKB-L2066	638289200	AKB-L2713	640303800	636301800	AKB-L2917	643308500	AKB-L2006
AKB-L2067	631300300	AKB-L2789	636301909	636301909	AKB-L2789	643308800	AKB-L2008
AKB-L2068	628300200	AKB-L2790	631300200	638289200	AKB-L2066	643309000	AKB-L2204
AKB-L2070	638309100	AKB-L2856	640302718	638290600	AKB-L1814	643309600	AKB-L2183
AKB-L2071	628287400	AKB-L2904	635306200	638297218	AKB-L2108	643310700	AKB-L2184
AKB-L2071	628300600	AKB-L2905	638301500	638301500	AKB-L2905	643312700	AKB-L2116
AKB-L2072	631289800	AKB-L2906	638301600	638301600	AKB-L2906	643318300	AKB-L1818
AKB-L2073	635290800	AKB-L2908	635301100	638305300	AKB-L2266	643318400	AKB-L2009
AKB-L2074	635287600	AKB-L2912	635306600	638308500	AKB-L2973	643320100	AKB-L2416
AKB-L2076	635290900	AKB-L2913	638308600	638308600	AKB-L2913	643320300	AKB-L2627
AKB-L2078	628101700	AKB-L2914	638308700	638308700	AKB-L2914	643320400	AKB-L2005
AKB-L2079	633300609	AKB-L2915	640303000	638309000	AKB-L2574	643320700	AKB-L2627
AKB-L2080	641295300	AKB-L2915	640304000	638309100	AKB-L2070	643320900	AKB-L2508
AKB-L2082	635306500	AKB-L2917	636301800	640274650	AKB-L1808	643321100	AKB-L2011
AKB-L2084	640300500	AKB-L2918	640303100	640292900	AKB-L1829	643321400	AKB-L2567
AKB-L2084	640300618	AKB-L2928	643321700	640295000	AKB-L1827	643321600	AKB-L2204
AKB-L2105	643291700	AKB-L2941	635299099	640295150	AKB-L1806	643321700	AKB-L2928
AKB-L2106	640297400	AKB-L2973	638308500	640297400	AKB-L2106	643323000	AKB-L2011
AKB-L2107	640300800	AKB-L2979	640303900	640297800	AKB-L1828	643325400	AKB-L2008
AKB-L2108	638297218	AKB-L2983	640301409	640300100	AKB-L2001	643325809	AKB-L2204
AKB-L2109	640302518	AKB-L3000	635300500	640300500	AKB-L2084	643325900	AKB-L2014
AKB-L2115	642306700	AKB-L3173	633101900	640300618	AKB-L2084	643326200	AKB-L2456
AKB-L2116	643312700	AKB-L3173	633306700	640300800	AKB-L2107		
AKB-L2121	642305400	628101700	AKB-L2078	640301218	AKB-L2284		

LIPE/Sachs Cross Reference

Lipe	Sachs	Lipe	Sachs	Lipe	Sachs	Lipe	Sachs
AKB-L1806	3400 077 071	AKB-L2078	3400 066 031	AKB-L2295	SA1	AKB-L3264	3400 700 352
AKB-L1808	3400 074 031	AKB-L2079	3400 700 322	AKB-L2416	3400 127 101	AKB-L3264	3400 700 370
AKB-L1808	3400 107 031	AKB-L2080	3400 700 301	AKB-L2456	3400 700 314	AKB-L3264	3400 700 371
AKB-L1814	3400 037 031	AKB-L2082	SA47	AKB-L2505	3400 700 307	AKB-L3264	3400 700 372
AKB-L1817	SA13	AKB-L2084	3400 121 501	AKB-L2505	3400 700 353	AKB-L3264	3400 700 373
AKB-L1818	3400 700 319	AKB-L2084	3400 121 601	AKB-L2506	3400 700 308	AKB-L3264	3400 700 374
AKB-L1822	3400 116 101	AKB-L2084	3400 700 355	AKB-L2508	3400 700 343	AKB-L2008	3400 700 504
AKB-L1823	3400 124 301	AKB-L2105	3400 122 601	AKB-L2511	3400 700 430	AKB-L2008	3400 700 521
AKB-L1825	3400 125 001	AKB-L2106	3400 121 901	AKB-L2567	3400 700 342	AKB-L2506	3400 700 501
AKB-L1825	3400 125 101	AKB-L2107	3400 093 031	AKB-L2574	3400 700 348	AKB-L2915	3400 700 502
AKB-L1826	3400 067 031	AKB-L2108	3400 700 325	AKB-L2627	3400 127 401		
AKB-L1826	3400 700 449	AKB-L2108	3400 700 326	AKB-L2627	3400 700 402		
AKB-L1827	3400 084 031	AKB-L2108	3400 700 426	AKB-L2713	3400 700 311		
AKB-L1828	3400 123 601	AKB-L2108	3400 700 427	AKB-L2789	3400 700 303		
AKB-L1829	3400 123 501	AKB-L2109	3400 700 406	AKB-L2790	SA15		
AKB-L2000	3400 700 310	AKB-L2109	3400 700 407	AKB-L2854	3488 019 133		
AKB-L2001	3400 121 701	AKB-L2115	1800 107 133	AKB-L2856	3400 700 360		
AKB-L2004	3400 124 001	AKB-L2116	3400 700 305	AKB-L2856	3400 700 422		
AKB-L2005	3400 700 411	AKB-L2121	1800 125 301	AKB-L2856	3400 700 423		
AKB-L2006	3400 122 301	AKB-L2138	1800 125 501	AKB-L2891	3400 700 409		
AKB-L2007	3400 122 201	AKB-L2162	3400 033 032	AKB-L2893	3400 700 332		
AKB-L2008	3400 122 101	AKB-L2162	3400 040 032	AKB-L2894	3400 700 410		
AKB-L2008	3400 700 361	AKB-L2162	3400 106 031	AKB-L2895	3400 700 334		
AKB-L2009	3400 043 032	AKB-L2169	3400 122 901	AKB-L2903	3400 700 354		
AKB-L2009	3400 127 201	AKB-L2174	3400 124 101	AKB-L2904	SA2		
AKB-L2011	3400 117 801	AKB-L2176	3400 122 501	AKB-L2905	SA4		
AKB-L2011	3400 700 403	AKB-L2178	3400 123 001	AKB-L2906	SA10		
AKB-L2011	3400 700 404	AKB-L2183	3400 123 801	AKB-L2908	SA14		
AKB-L2012	3400 117 802	AKB-L2184	3400 123 701	AKB-L2912	SA48		
AKB-L2014	3400 700 324	AKB-L2185	3400 035 032	AKB-L2913	SA49		
AKB-L2014	3400 710 004	AKB-L2187	3400 121 002	AKB-L2914	SA50		
AKB-L2015	SA29	AKB-L2204	3400 122 801	AKB-L2915	3400 700 320		
AKB-L2018	3400 121 801	AKB-L2204	3400 700 413	AKB-L2917	3400 700 318		
AKB-L2050	SA7	AKB-L2204	3400 700 414	AKB-L2918	3400 700 316		
AKB-L2059	3400 700 417	AKB-L2204	3400 700 415	AKB-L2928	3400 700 350		
AKB-L2061	3400 122 401	AKB-L2204	3400 700 416	AKB-L2941	3400 031 033		
AKB-L2066	3400 037 032	AKB-L2205	3400 122 701	AKB-L2969	3400 700 424		
AKB-L2067	3400 125 801	AKB-L2208	3400 127 901	AKB-L2973	SA26		
AKB-L2068	3400 124 201	AKB-L2266	SA51	AKB-L2979	3400 700 337		
AKB-L2070	3400 700 412	AKB-L2273	SA39	AKB-L2983	3400 121 201		
AKB-L2071	3400 125 201	AKB-L2277	3400 121 301	AKB-L3000	1800 125 001		
AKB-L2071	3400 127 301	AKB-L2279	3400 700 405	AKB-L3038	3400 122 201		
AKB-L2072	3400 124 501	AKB-L2279	3400 700 428	AKB-L3135	3400 710 002		
AKB-L2073	3400 124 801	AKB-L2283	3400 127 701	AKB-L3173	3400 068 031		
AKB-L2074	3400 124 901	AKB-L2284	3400 117 532	AKB-L3173	3400 700 431		
AKB-L2076	3400 125 501	AKB-L2285	3400 700 339	AKB-L3263	3400 700 357		

LIPE/Sachs Cross Reference

Sachs	Lipe	Sachs	Lipe	Sachs	Lipe	Sachs	Lipe
1800 107 133	AKB-L2115	3400 123 801	AKB-L2183	3400 700 355	AKB-L2084	SA26	AKB-L2973
1800 125 001	AKB-L3000	3400 124 001	AKB-L2004	3400 700 357	AKB-L3263	SA29	AKB-L2015
1800 125 301	AKB-L2121	3400 124 101	AKB-L2174	3400 700 360	AKB-L2856	SA39	AKB-L2273
1800 125 501	AKB-L2138	3400 124 201	AKB-L2068	3400 700 361	AKB-L2008	SA4	AKB-L2905
3400 031 033	AKB-L2941	3400 124 301	AKB-L1823	3400 700 370	AKB-L3264	SA47	AKB-L2082
3400 033 032	AKB-L2162	3400 124 501	AKB-L2072	3400 700 371	AKB-L3264	SA48	AKB-L2912
3400 035 032	AKB-L2185	3400 124 801	AKB-L2073	3400 700 372	AKB-L3264	SA49	AKB-L2913
3400 037 031	AKB-L1814	3400 124 901	AKB-L2074	3400 700 373	AKB-L3264	SA50	AKB-L2914
3400 037 032	AKB-L2066	3400 125 001	AKB-L1825	3400 700 374	AKB-L3264	SA51	AKB-L2266
3400 040 032	AKB-L2162	3400 125 101	AKB-L1825	3400 700 402	AKB-L2627	SA7	AKB-L2050
3400 043 032	AKB-L2009	3400 125 201	AKB-L2071	3400 700 403	AKB-L2011		
3400 066 031	AKB-L2078	3400 125 501	AKB-L2076	3400 700 404	AKB-L2011		
3400 067 031	AKB-L1826	3400 125 801	AKB-L2067	3400 700 405	AKB-L2279		
3400 068 031	AKB-L3173	3400 127 101	AKB-L2416	3400 700 406	AKB-L2109		
3400 074 031	AKB-L1808	3400 127 201	AKB-L2009	3400 700 407	AKB-L2109		
3400 077 071	AKB-L1806	3400 127 301	AKB-L2071	3400 700 409	AKB-L2891		
3400 084 031	AKB-L1827	3400 127 401	AKB-L2627	3400 700 410	AKB-L2894		
3400 093 031	AKB-L2107	3400 127 701	AKB-L2283	3400 700 411	AKB-L2005		
3400 106 031	AKB-L2162	3400 127 901	AKB-L2208	3400 700 412	AKB-L2070		
3400 107 031	AKB-L1808	3400 700 301	AKB-L2080	3400 700 413	AKB-L2204		
3400 116 101	AKB-L1822	3400 700 303	AKB-L2789	3400 700 414	AKB-L2204		
3400 117 532	AKB-L2284	3400 700 305	AKB-L2116	3400 700 415	AKB-L2204		
3400 117 801	AKB-L2011	3400 700 307	AKB-L2505	3400 700 416	AKB-L2204		
3400 117 802	AKB-L2012	3400 700 308	AKB-L2506	3400 700 417	AKB-L2059		
3400 121 002	AKB-L2187	3400 700 310	AKB-L2000	3400 700 422	AKB-L2856		
3400 121 201	AKB-L2983	3400 700 311	AKB-L2713	3400 700 423	AKB-L2856		
3400 121 301	AKB-L2277	3400 700 314	AKB-L2456	3400 700 424	AKB-L2969		
3400 121 501	AKB-L2084	3400 700 316	AKB-L2918	3400 700 426	AKB-L2108		
3400 121 601	AKB-L2084	3400 700 318	AKB-L2917	3400 700 427	AKB-L2108		
3400 121 701	AKB-L2001	3400 700 319	AKB-L1818	3400 700 428	AKB-L2279		
3400 121 801	AKB-L2018	3400 700 320	AKB-L2915	3400 700 430	AKB-L2511		
3400 121 901	AKB-L2106	3400 700 322	AKB-L2079	3400 700 431	AKB-L3173		
3400 122 101	AKB-L2008	3400 700 324	AKB-L2014	3400 700 449	AKB-L1826		
3400 122 201	AKB-L2007	3400 700 325	AKB-L2108	3400 700 501	AKB-L2506		
3400 122 201	AKB-L3038	3400 700 326	AKB-L2108	3400 700 502	AKB-L2915		
3400 122 301	AKB-L2006	3400 700 332	AKB-L2893	3400 700 504	AKB-L2008		
3400 122 401	AKB-L2061	3400 700 334	AKB-L2895	3400 700 521	AKB-L2008		
3400 122 501	AKB-L2176	3400 700 337	AKB-L2979	3400 710 002	AKB-L3135		
3400 122 601	AKB-L2105	3400 700 339	AKB-L2285	3400 710 004	AKB-L2014		
3400 122 701	AKB-L2205	3400 700 342	AKB-L2567	3488 019 133	AKB-L2854		
3400 122 801	AKB-L2204	3400 700 343	AKB-L2508	SA1	AKB-L2295		
3400 122 901	AKB-L2169	3400 700 348	AKB-L2574	SA10	AKB-L2906		
3400 123 001	AKB-L2178	3400 700 350	AKB-L2928	SA13	AKB-L1817		
3400 123 501	AKB-L1829	3400 700 352	AKB-L3264	SA14	AKB-L2908		
3400 123 601	AKB-L1828	3400 700 353	AKB-L2505	SA15	AKB-L2790		
3400 123 701	AKB-L2184	3400 700 354	AKB-L2903	SA2	AKB-L2904		



Information Letter 5

Clutch Mounting Bolt Kits

Part Number	Clutch	Quantity
X097-L0786	330-61-L499 With .5 Flange	9 Off 8mm
X097-L0787	330-61-L499 With .125 Flange	9 Off 8mm
X097-L0615	Cap Screw 15/380 UN	1 Off (2 Required)
X097-L0731	Cap Screw 15/380 UNF	1 Off (2 Required)
X097-L0779	14-2 LP	12 Off UNF
X097-L0780	14-2 LP	12 Off UNC
X097-L0976	14-2 LP LeylandTI11	12 Off BSF
X097-L0777	15 ¹ / ₂ -2LP	12 Off UNC
X097-L0778	15 ¹ / ₂ -2LP	12 Off UNF
X097-L0982	Metric 380 + 420	12 Off
X097-L0775	15/380-2 LP	10 Off Bolts 2 Off Capscrews UNC
X097-L0776	15/380-2 LP	10 Off Bolts 2 Off Capscrews UNF
X097-L0450	14-2 LP	4 Off UNC Bolts ³ / ₈
X097-L0451	14-2 LP	4 Off UNF Bolts ³ / ₈
X097-L0452	15 ¹ / ₂ -2 LP	4 Off UNC Bolts ⁷ / ₁₆
X097-L0453	15 ¹ / ₂ -2 LP	4 Off UNF Bolts ⁷ / ₁₆
X097-L0781	14-2 Flat Fly	12 Off UNC Bolt ³ / ₈



Instruction for installation of flat flywheel adaptor kit for 14-2 LP Models

Fitted in Leyland Constructor with 8.25 DAF engine

Carefully inspect the flywheel for scores, heat cracks, taper and parrallelism to the crankshaft mounting surface. Remachine if necessary. If the flywheel is severely heat checked or worn it should be replaced.

We suggest that standard $\frac{3}{8}$ " x 16 UNC cap screws 3" long be used as pilots. Cut the heads from these cap screws, saw a screw driver slot in the end and install them in opposite holes in the flywheel. These pilots will support the adaptor ring as the clutch is installed.

Position the adaptor ring on the flywheel, ensuring that the ventilating slots are on the flywheel side.

With a spline alignment tool, align the driven discs and intermediate plate in the flywheel adaptor ring. Attach the clutch cover assembly to the flywheel using the 12 cap screws provided in the adaptor kit. Do not tighten any cap screws until all 12 have been installed and finger tight.

The AK-L0974 has (12) X2-37 cap screws 2" long and can only be used on flywheels with fully tapped clutch mounting holes, ie. not counterbored. This applies to DAF 8.25 litre engines only.

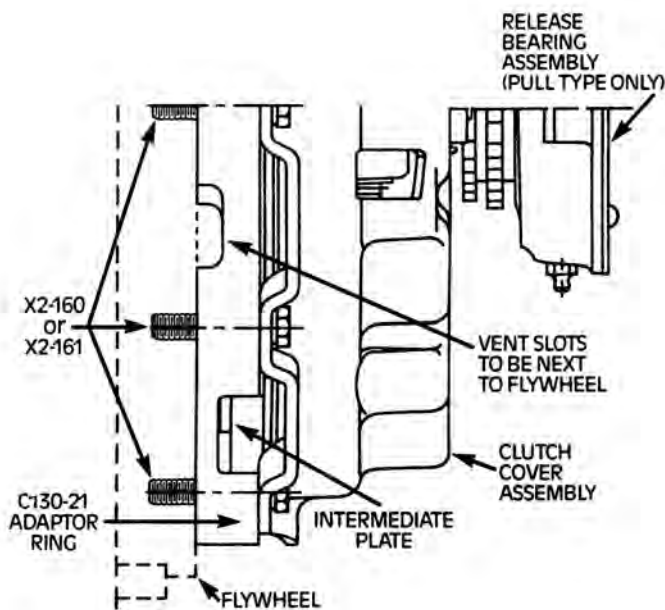



Information Letter 14

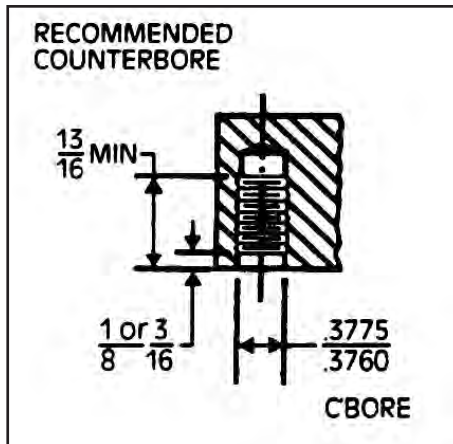

Flywheel Saver Kit

**AK-L1109 for 13/330 and
AK-L1110 for 14" Single Plate Clutches**

Lipe have developed a Flywheel Saver Kit that will make a worn flywheel serviceable again without the need for expensive regrinding and downtime.

The flywheel Saver Kit is suitable for the Cummins 6B range of engines with an Eaton gearbox as fitted to ERF E6 and ES6 as well as the Ford Cargo 1218 to 1718.

The kit consists of a flywheel face plate, bolts, washers, release bearing, release bearing carrier and flywheel spigot bearing.

Important

Before fitting the Lipe Flywheel Saver Kit it is recommended that you check the clutch mounting bolt drillings in the flywheel to ensure they comply to the drawing illustrated. If the bolt counterbore is not as shown, the clutch mounting bolts will be bottom out, thus not securing the clutch to the flywheel.



Information Letter 27



380mm Heavy Duty Ceramic Assemblies for Iveco Vehicles fitted with a 406mm Clutch Assembly.

Spline Size 2" x 10
Disc Assembly
Part No. 380-609-L1188

Spline Size 1³/₄" x 10
Disc Assembly
Part No. 380-609-L1189

Both discs are designed to fit under the original Iveco
clutch cover assembly.

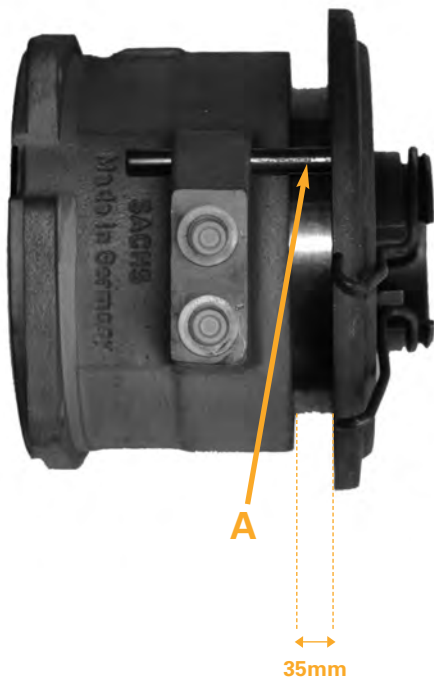

MAN Integral Slave Cylinder

IMPORTANT
Clutch Pack LP-L1654-607 and
Kits AK-L1615, AK-L1616, AKB-L2079

Having completed the clutch installation and before re-installing the transmission, the integral slave cylinder piston must be extended until the 35mm dimension is obtained.

This is achieved by pushing the spiral pins 'A' towards the front of the transmission ie. towards the clutch cover assembly.

Note: adjustment of the slave cylinder piston cannot be carried out once the transmission is installed..

If a new slave cylinder has been fitted the piston will be pre-set at 35mm, but it is recommended that this is checked.



Information Letter 30



Lipe DLPS Clutch Packs

LP-L1868AK-608
5 PADDLE DISC
2 OFF
1800 LBS FT

LP-L1868AK-688
4 PADDLE DISC
2 OFF
1422 LBS FT

Lipe's DLPS clutch packs are a direct interchange with the Eaton/Fuller (Spicer) 7 spring dampener clutch fitted on ERF, Foden and Seddon Atkinson vehicles with the Cummins M11 engines. These engines have a flywheel internal diameter of 10.125" which accepts the larger dampener centre. The major difference between the Lipe and Eaton/Fuller (Spicer) is the driven discs.

The 4 and 5 paddle Lipe discs are totally symmetrical, allowing the parts to be either way. The clutch packs contain all the components needed to retro-fit the Lipe clutch onto either the Cummins or Perkins engine.

LP-L1868AK-608 comprises:

LP-L1868-608 Clutch Pack
 1-off Adaptor Ring
 2-off UNC Capscrews
 2-off UNF Capscrews
 2-off UNC $\frac{7}{16} \times 2\frac{1}{2}$ " Bolts
 2-off UNF $\frac{7}{16} \times 2\frac{1}{2}$ " Bolts
 2-off $\frac{7}{16}$ Spring Washer

LP-L1868AK-688 comprises:

LP-L1868-688 Clutch Pack
 1-off Adaptor Ring
 2-off UNC Capscrews
 2-off UNF Capscrews
 2-off UNC $\frac{7}{16} \times 2\frac{1}{2}$ " Bolts
 2-off UNF $\frac{7}{16} \times 2\frac{1}{2}$ " Bolts
 2-off $\frac{7}{16}$ Spring Washer

Note: for service installations full kit LP-L1868AK-608 or LP-L1868AK-688 must be fitted.



Scania Integral Slave Cylinder

IMPORTANT

Lipe Clutch Kit for Scania 4 Series Vehicles AK-L1683, AKB-L2017, AKB-L2014

Having completed the clutch installation and before re-installing the transmission, the integral slave cylinder piston must be extended. The following method is recommended by Scania (GB) Ltd.

1. Lightly lubricate the spring pins 'A' with an anti-corrosive oil.
2. Check piston/clutch retaining ring for wear and change if worn.
3. Extend the slave cylinder piston forward until the end of the spring pins 'A' are level with the rear face of the bosses which the spring pins slide through.
4. Align the gearbox and push into position when the slave cylinder piston engages into the diaphragm spring. A click can clearly heard.

Note: It is very important when installing the gearbox to control its vertical and horizontal position. This is so that the slave cylinder piston and retaining ring are not damaged during fitment.

Do not squeeze the ends of the retainer ring after assembly as the slave cylinder may become detached from the diaphragm.

Lipe cast cover assemblies interchange with press steel covers.



Information Letter 34

1. Open



2. Insert shaft



3. Shaft



BK312 & BK313 Fitting Instructions

1 3/4" & 2" Spline

Initially Ensure the transmission is in gear, the clutch is correctly adjusted (1/2" gap between the release bearing housing and clutch brake) and make sure the clutch linkage allows the release bearing to contact the clutch brake.

Step 1 Insert a screwdriver into the slot by the roll pin and separate.

Step 2 Open the clutch brake as wide as possible.

Step 3 Install the plastic button side toward the transmission cap.

Step 4 Place the clutch brake over the input shaft and insert the the drive tang closest to the expansion pin into the shaft so that it snaps into position.

Step 5 To automatically set the pin (after snapping the clutch brake together), fully depress the clutch pedal to depress the pin into position.

Step 6 Visually verify the plastic button is seated flush with the friction material on the clutch brake. If not, repeat Step 5.

Warning Incorrect clutch adjustment will prevent the roll pin from being fully seated and will cause the assembly to come apart during the operation.

Clutch Brake Removal Instructions

Remove the transmission inspection cover. Insert a screwdriver into the slot by the roll pin and separate.



Information Letter 37

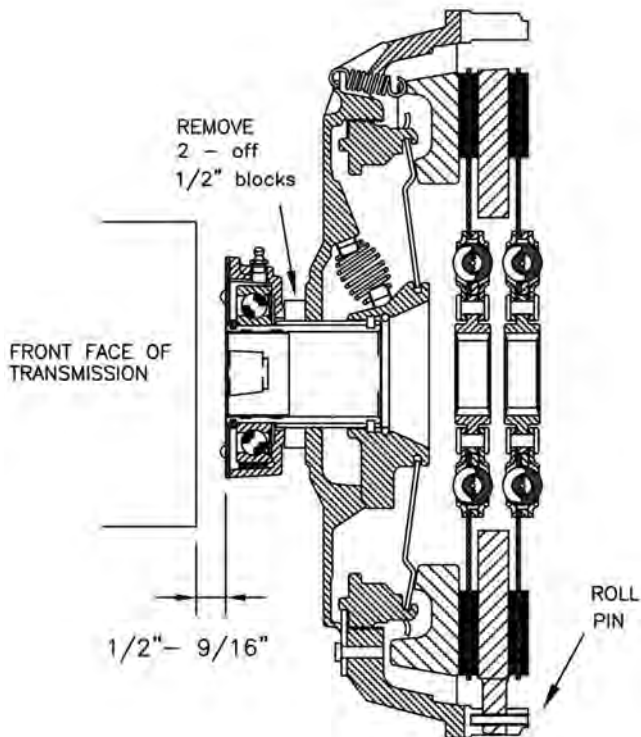

1. Before installing the clutch, check the flywheel for wear.
2. Apply Lipe Spline Lube to the disc hub splines and input shaft spline.
3. Install clutch to flywheel face.
4. Adjust clutch by removing lock strap and turning adjusting ring to allow the two shipping blocks to fall out. Note: fitter or service engineer must ensure both blocks are removed from clutch before installing transmission.
5. Install transmission
6. Re-adjust clutch until the gap between the front face of the transmission and the release bearing is as per the vehicle manufacturer's specification ($1/2'' - 9/16''$).

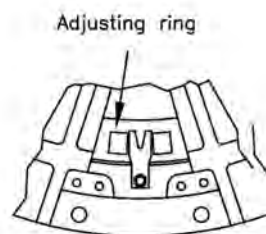

Turn the adjusting ring clockwise to decrease the gap between the front face of the transmission and the release bearing.

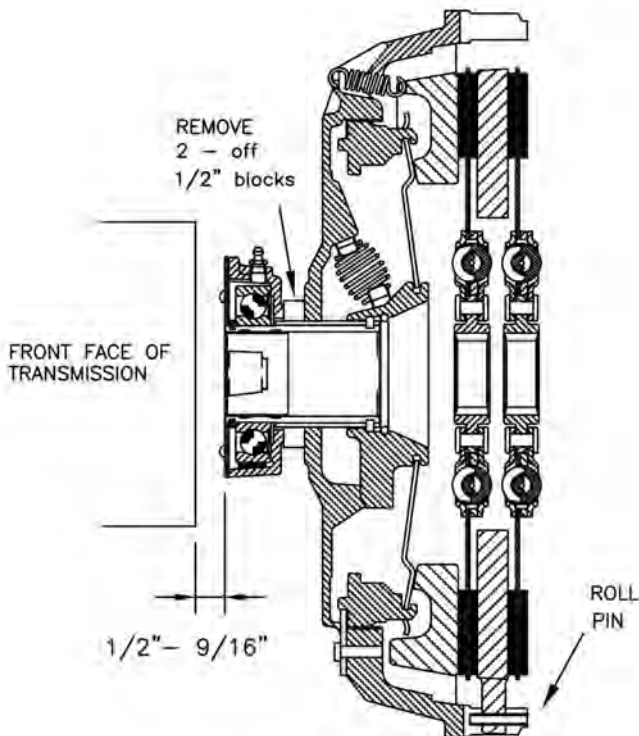

1. Before installing the clutch assembly, check the flywheel for wear.
2. Apply Lipe Spline Lube to the disc hub splines and input shaft spline.
3. These units are supplied with Lipe DLPS disc assemblies. The disc assemblies are symmetrical. They can be fitted in either flywheel or pressure plate positions.
4. Install the clutch assembly to the flywheel face.
5. Adjust clutch by removing lock strap and turning adjusting ring to allow the two shipping blocks to fall out. Note: the dummy input shaft must be left in situ while carrying out instructions detailed in (4) & (5).
6. Before installing transmission, gently tap the four roll pins forward in the intermediate plate lugs onto the flywheel face through the four holes in the the cover assembly.
7. Install transmission
8. Check clutch adjustment between transmission face and release bearing as per vehicle manufacturer's specification. Note: normally $1/2'' - 9/16''$

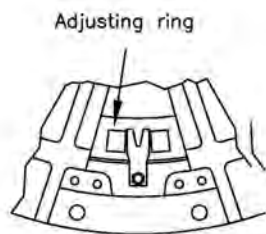

Turn the adjusting ring clockwise to decrease the gap between the front face of the transmission and the release bearing.

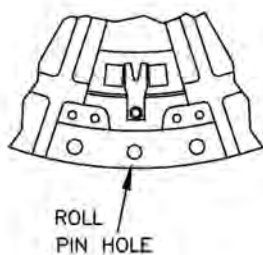

ROLL PIN HOLE



Information Letter 43A

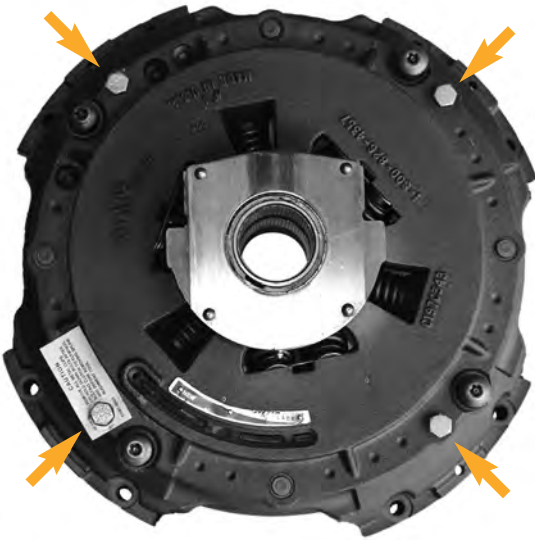

Picture 1: Remove four yellow bolts

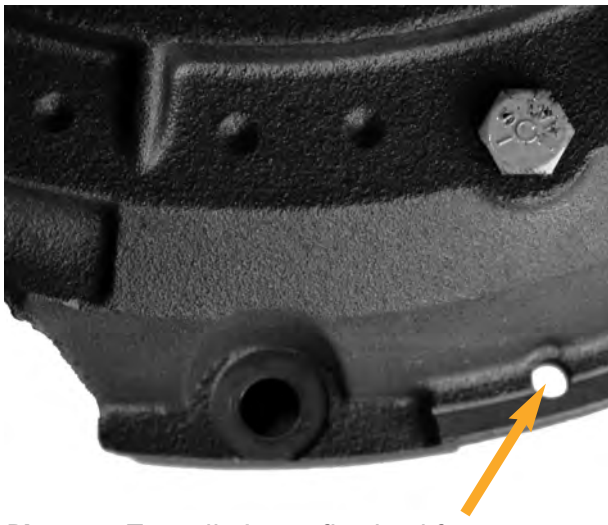

Picture 1: Tap roll pins to flywheel face

15¹/₂-2 Solo SP-L2566

1. Before installing the clutch assembly, check the flywheel for wear.
2. Apply Lipe Spline Lube to the disc hub splines and input shaft.
3. These units are supplied with DLPS disc assemblies. The disc assemblies are symmetrical. They can be fitted in either flywheel or pressure plate positions.
4. Install the clutch assembly to the flywheel.
5. Remove the 4 yellow coloured shipping bolts in a criss cross pattern (see picture 1). Note: save the 7/16 UNC 2" long bolts in case you need to remove and then reinstall the clutch. Before doing so contact Lipe for refitting procedure.
6. Before installing transmission, gently tap the four roll pins forward in the interplate lugs onto the flywheel face through the four holes in the cover (see picture 2).
7. Install transmission.
8. After the transmission and linkage has been reconnected, fully depress the clutch pedal five times to set the clutch.
9. Check wear indicator tab to see if it has moved to the new position. If not, disconnect the linkage and place a tube over the release arm and stroke the clutch manually five times to ensure the clutch adjusts to its new position.
10. Note: failure to set the clutch to the above procedure will result in premature failure and will nullify warranty.

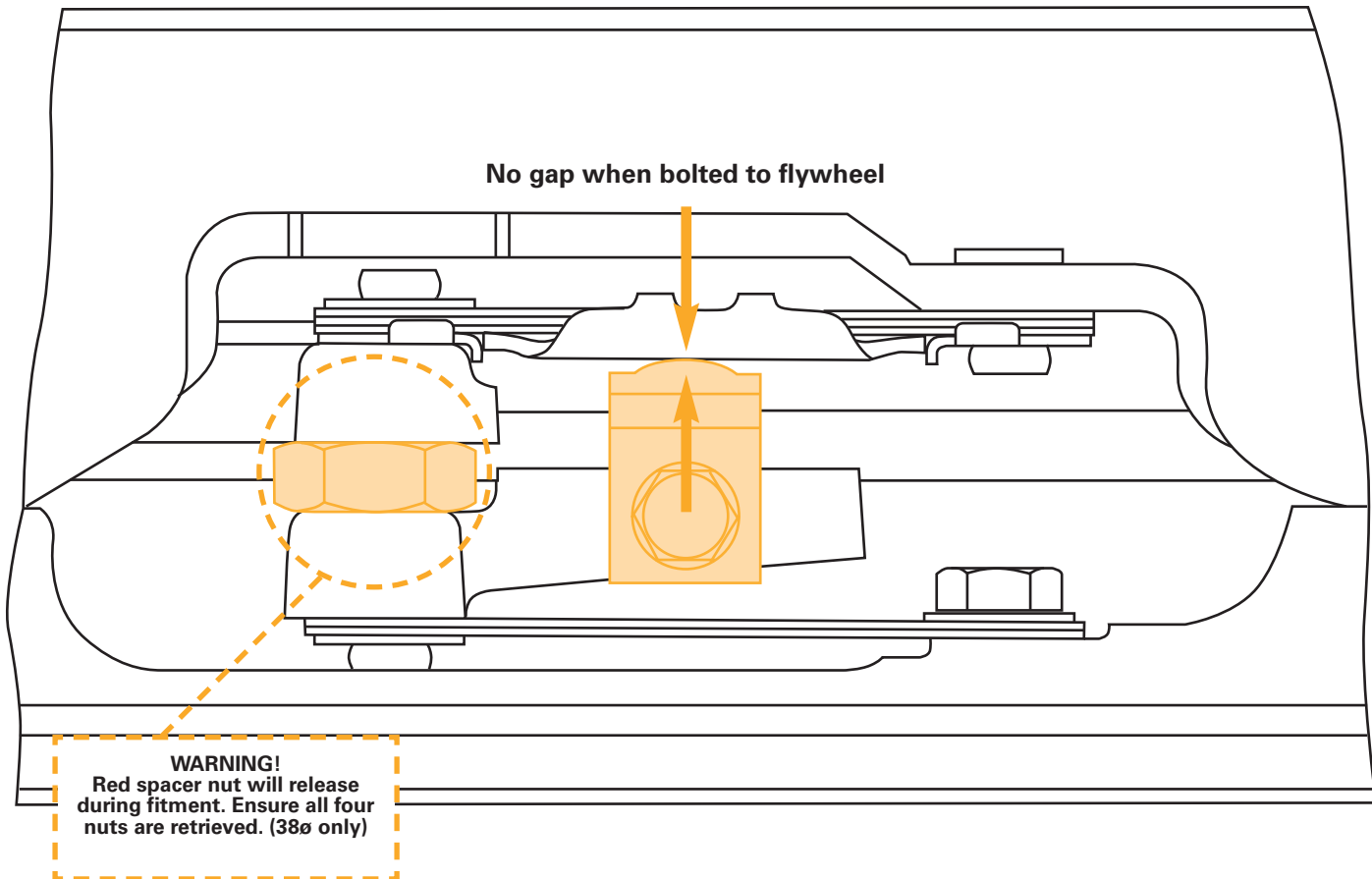

380/400mm Twin Plate

Before fitment;

- Check the flywheel face for wear (run out). The maximum allowable is 0.5mm [0.02"]

Once clutch is bolted to flywheel ensure;

- All four red spacer nuts are retrieved (380's only).
- The four bolts holding the cover to the adapter ring remain tight.
- The tee stops are lightly touching.

NOTE: Worn flywheels or discs will require Tee stop adjustment. Torque to 28N/M [21lb/ft] and thread-lock.

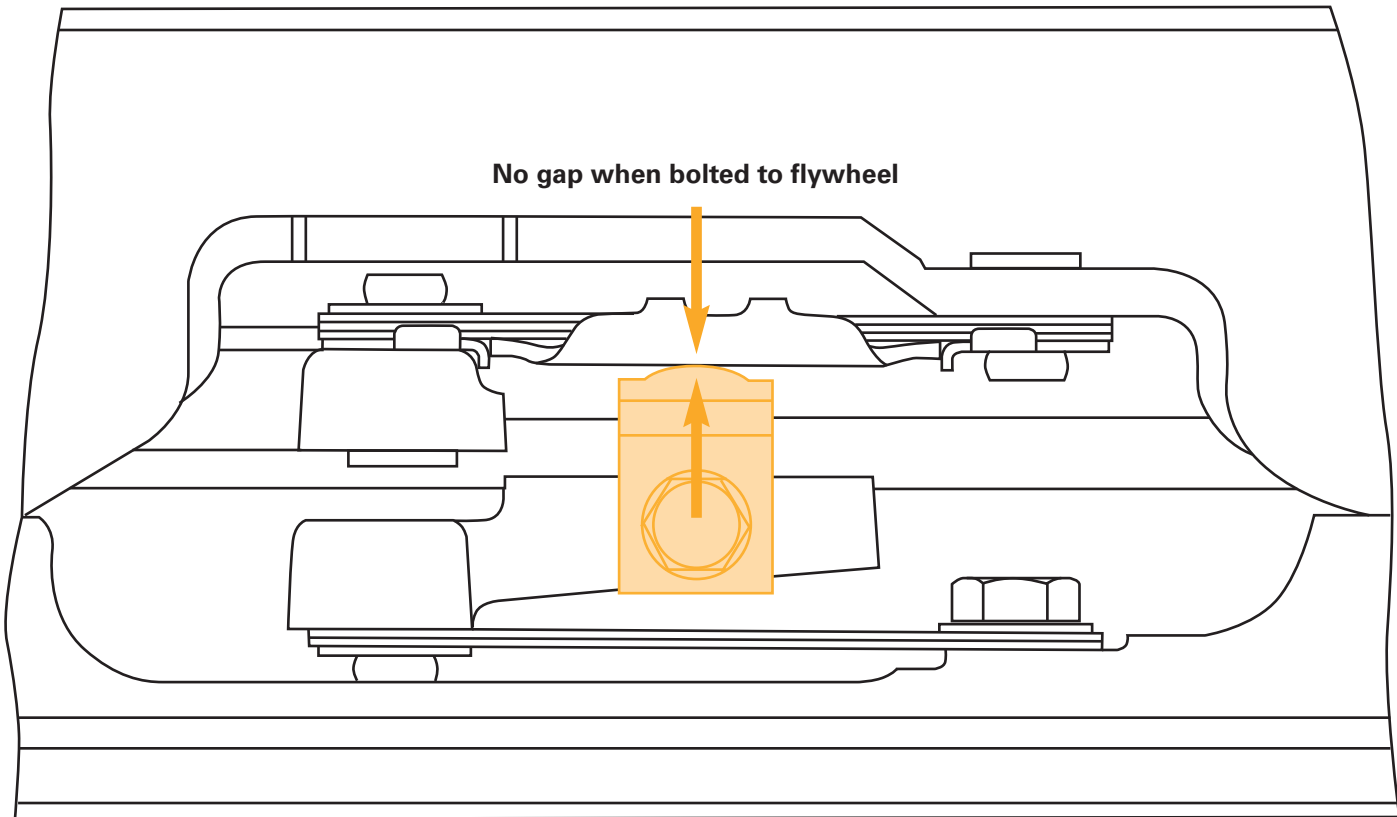

400mm Twin Plate

- 1) Check the flywheel face for wear (run out). The maximum allowable is 0.5mm [0.02"]
- 2) Ensure the four bolts holding the cover to the adapter ring remain tight after bolting to flywheel.
- 3) Check to ensure the Tee stops are lightly touching when the unit is fully bolted up to the flywheel.
 - Worn flywheels or discs will require Tee stop adjustment.

Note: Side Tee stops are pre-set (Torqued to 28 N/M [21lb/ft] and lock-tightened).

